**User's
Manual**

**WX102
DAQ 32 Plus**

**WX82
DAQ 32 Plus Client Package**

vigilantplant®

Foreword

Thank you for purchasing DAQ 32 Plus or DAQ 32 Plus Client Package software. This User's Manual contains useful information regarding the operation of DAQ 32 Plus and DAQ 32 Plus Client Package using Windows 2000, Windows XP, and Windows Vista. To ensure proper use of the software, please read this manual thoroughly before operating it. Keep the manual in a safe place for quick reference whenever a question arises.

Notes

- The DARWIN data acquisition equipment series will improve its expandability and flexibility while introducing new models, software, various input/output modules, optional functions to its product lineup. When constructing a system, make sure that the hardware style No. and software release No., which indicate the version of system component units, conform to the following requirements.
 - The style No. of each input/output module is equal to or smaller than that of the main unit/ subunit to which it is to be connected.
 - The release No. of the specifically designed package software is equal to or larger than that of the main unit/subunit which carries out setting and control.It is not possible to construct a system with any equipment and software which does not conform to the requirements. DAQ 32 Plus and DAQ 32 Plus Client Package are used in combination, and have the same release number (but different serial numbers).
- The contents of this manual are subject to change without prior notice as a result of improvements in the software's performance and functions. Display contents illustrated in this manual may differ slightly from what actually appear on your screen.
- Every effort has been made in the preparation of this manual to ensure the accuracy of its contents. However, should you have any questions or find any errors, please contact your nearest YOKOGAWA representative listed on the back cover of this manual.
- The copy or reproduction of all or any part of the contents of this manual without YOKOGAWA's permission is strictly prohibited.
- It is forbidden to use this software with two or more computers simultaneously. It is also forbidden for two or more users to use this software.
- It is forbidden to lease or rent this software to a third person.
- YOKOGAWA will not guarantee the condition of the software, except for physical damage to the original disk, once the software packaging is removed.
- YOKOGAWA will not be responsible for any damage caused directly or indirectly as a result of this software.
- **The license number will not be reissued. Please keep the license number in a safe place.**

Trademarks

- DAQWORX, DAQLOGGER, and DAQEXPLORER are registered trademarks or trademarks of Yokogawa Electric Corporation.
- Microsoft and Windows are registered trademarks or trademarks of Microsoft Corporation in the United States and/or other countries.
- Adobe and Acrobat are registered trademarks or trademarks of Adobe Systems Incorporated.
- Company and product names that appear in this manual are registered trademarks or trademarks of their respective holders.
- The company and product names used in this manual are not accompanied by the registered trademark or trademark symbols (® and ™).

Revisions

- 1st Edition: July 2003
- 2nd Edition: June 2007
- 3rd Edition: March 2008

Terms and Conditions of the Software License

NOTICE - PLEASE READ CAREFULLY BEFORE USE

Thank you very much for purchasing this medium containing a software program and related documentation provided by Yokogawa Electric Corporation (hereinafter called "Yokogawa"), and the program contained, embedded, inserted or used in the medium (hereinafter called the "Yokogawa Software Program").

By opening this package or plastic wrapping (hereinafter called "Package") enclosing the Yokogawa Software Program, you acknowledge that you understand and agree to the "Terms and Conditions of the Software License" (hereinafter called "Terms and Conditions") which is written in the documentation and separately attached. Accordingly, the Terms and Conditions bind you.

The Yokogawa Software Program and its related documentation including ownership of copyright shall remain the exclusive property of Yokogawa or those third parties from whom sublicensed software in the Yokogawa Software Program is licensed.

Yokogawa hereby grants you permission to use the Yokogawa Software Program on the conditions that you agree to the Terms and Conditions before you open the Package and/or install it in or onto a computer.

IF YOU DO NOT AGREE TO THE TERMS AND CONDITIONS, YOU CANNOT OPEN THE PACKAGE, AND MUST IMMEDIATELY RETURN IT TO YOKOGAWA OR ITS DESIGNATED PARTY.

Terms and Conditions of the Software License

Yokogawa Electric Corporation, a Japanese corporation (hereinafter called "Yokogawa"), grants permission to use this Yokogawa Software Program (hereinafter called the "Licensed Software") to the Licensee on the conditions that the Licensee agrees to the terms and conditions stipulated in Article 1 hereof.

You, as the Licensee (hereinafter called "Licensee"), shall agree to the following terms and conditions for the software license (hereinafter called the "Agreement") based on the use intended for the Licensed Software.

Please note that Yokogawa grants the Licensee permission to use the Licensed Software under the terms and conditions herein and in no event shall Yokogawa intend to sell or transfer the Licensed Software to the Licensee.

Licensed Software Name: DAQ32Plus (Model WX102) or DAQ32Plus Client Package (Model WX82)

Number of License: 1

Article 1 (Scope Covered by these Terms and Conditions)

- 1.1 The terms and conditions stipulated herein shall be applied to any Licensee who purchases the Licensed Software on the condition that the Licensee consents to agree to the terms and conditions stipulated herein.
- 1.2 The "Licensed Software" herein shall mean and include all applicable programs and documentation, without limitation, all proprietary technology, algorithms, and know-how such as a factor, invariant or process contained therein.

Article 2 (Grant of License)

- 2.1 Yokogawa grants the Licensee, for the purpose of single use, non-exclusive and non-transferable license of the Licensed Software with the license fee separately agreed upon by both parties.
- 2.2 The Licensee is, unless otherwise agreed in writing by Yokogawa, not entitled to copy, change, sell, distribute, transfer, or sublicense the Licensed Software.
- 2.3 The Licensed Software shall not be copied in whole or in part except for keeping one (1) copy for back-up purposes. The Licensee shall secure or supervise the copy of the Licensed Software by the Licensee itself with great, strict, and due care.
- 2.4 In no event shall the Licensee dump, reverse assemble, reverse compile, or reverse engineer the Licensed Software so that the Licensee may translate the Licensed Software into other programs or change it into a man-readable form from the source code of the Licensed Software. Unless otherwise separately agreed by Yokogawa, Yokogawa shall not provide the Licensee the source code for the Licensed Software.
- 2.5 The Licensed Software and its related documentation shall be the proprietary property or trade secret of Yokogawa or a third party which grants Yokogawa the rights. In no event shall the Licensee be transferred, leased, sublicensed, or assigned any rights relating to the Licensed Software.
- 2.6 Yokogawa may use or add copy protection in or onto the Licensed Software. In no event shall the Licensee remove or attempt to remove such copy protection.
- 2.7 The Licensed Software may include a software program licensed for re-use by a third party (hereinafter called "Third Party Software", which may include any software program from affiliates of Yokogawa made or coded by themselves.) In the case that Yokogawa is granted permission to sublicense to third parties by any licensors (sublicensor) of the Third Party Software pursuant to different terms and conditions than those stipulated in this Agreement, the Licensee shall observe such terms and conditions of which Yokogawa notifies the Licensee in writing separately.
- 2.8 In no event shall the Licensee modify, remove or delete a copyright notice of Yokogawa and its licensor contained in the Licensed Software, including any copy thereof.

Article 3 (Restriction of Specific Use)

- 3.1 The Licensed Software shall not be intended specifically to be designed, developed, constructed, manufactured, distributed or maintained for the purpose of the following events:
 - a) Operation of any aviation, vessel, or support of those operations from the ground;;
 - b) Operation of nuclear products and/or facilities;;
 - c) Operation of nuclear weapons and/or chemical weapons and/or biological weapons; or
 - d) Operation of medical instrumentation directly utilized for humankind or the human body.
- 3.2 Even if the Licensee uses the Licensed Software for the purposes in the preceding Paragraph 3.1, Yokogawa has no liability to or responsibility for any demand or damage arising out of the use or operations of the Licensed Software, and the Licensee agrees, on its own responsibility, to solve and settle the claims and damages and to defend, indemnify or hold Yokogawa totally harmless, from or against any liabilities, losses, damages and expenses (including fees for recalling the Products and reasonable attorney's fees and court costs), or claims arising out of and related to the above-said claims and damages.

Article 4 (Warranty)

- 4.1 The Licensee shall agree that the Licensed Software shall be provided to the Licensee on an "as is" basis when delivered. If defect(s), such as damage to the medium of the Licensed Software, attributable to Yokogawa is found, Yokogawa agrees to replace, free of charge, any Licensed Software on condition that the defective Licensed Software shall be returned to Yokogawa's specified authorized service facility within seven (7) days after opening the Package at the Licensee's expense. As the Licensed Software is provided to the Licensee on an "as is" basis when delivered, in no event shall Yokogawa warrant that any information on or in the Licensed Software, including without limitation, data on computer programs and program listings, be completely accurate, correct, reliable, or the most updated.
- 4.2 Notwithstanding the preceding Paragraph 4.1, when third party software is included in the Licensed Software, the warranty period and terms and conditions that apply shall be those established by the provider of the third party software.

- 4.3 When Yokogawa decides in its own judgement that it is necessary, Yokogawa may from time to time provide the Licensee with Revision upgrades and Version upgrades separately specified by Yokogawa (hereinafter called "Updates").
- 4.4 Notwithstanding the preceding Paragraph 4.3, in no event shall Yokogawa provide Updates where the Licensee or any third party conducted renovation or improvement of the Licensed Software.
- 4.5 THE FOREGOING WARRANTIES ARE EXCLUSIVE AND IN LIEU OF ALL OTHER WARRANTIES OF QUALITY AND PERFORMANCE, WRITTEN, ORAL, OR IMPLIED, AND ALL OTHER WARRANTIES INCLUDING ANY IMPLIED WARRANTIES OF MERCHANTABILITY OR FITNESS FOR A PARTICULAR PURPOSE ARE HEREBY DISCLAIMED BY YOKOGAWA AND ALL THIRD PARTIES LICENSING THIRD PARTY SOFTWARE TO YOKOGAWA.
- 4.6 Correction of nonconformity in the manner and for the period of time provided above shall be the Licensee's sole and exclusive remedy for any failure of Yokogawa to comply with its obligations and shall constitute fulfillment of all liabilities of Yokogawa and any third party licensing the Third Party Software to Yokogawa (including any liability for direct, indirect, special, incidental or consequential damages) whether in warranty, contract, tort (including negligence but excluding willful conduct or gross negligence by Yokogawa) or otherwise with respect to or arising out of the use of the Licensed Software.

Article 5 (Infringement)

- 5.1 If and when any third party should demand injunction, initiate a law suit, or demand compensation for damages against the Licensee under patent right (including utility model right, design patent, and trade mark), copy right, and any other rights relating to any of the Licensed Software, the Licensee shall notify Yokogawa in writing to that effect without delay.
- 5.2 In the case of the preceding Paragraph 5.1, the Licensee shall assign to Yokogawa all of the rights to defend the Licensee and to negotiate with the claiming party. Furthermore, the Licensee shall provide Yokogawa with necessary information or any other assistance for Yokogawa's defense and negotiation. If and when such a claim should be attributable to Yokogawa, subject to the written notice to Yokogawa stated in the preceding Paragraph 5.1, Yokogawa shall defend the Licensee and negotiate with the claiming party at Yokogawa's cost and expense and be responsible for the final settlement or judgment granted to the claiming party in the preceding Paragraph 5.1.
- 5.3 When any assertion or allegation of the infringement of the third party's rights defined in Paragraph 5.1 is made, or when at Yokogawa's judgment there is possibility of such assertion or allegation, Yokogawa will, at its own discretion, take any of the following countermeasures at Yokogawa's cost and expense.
- To acquire the necessary right from a third party which has lawful ownership of the right so that the Licensee will be able to continue to use the Licensed Software;
 - To replace the Licensed Software with an alternative one which avoids the infringement; or
 - To remodel the Licensed Software so that the Licensed Software can avoid the infringement of such third party's right.
- 5.4 If and when Yokogawa fails to take either of the countermeasures as set forth in the preceding subparagraphs of Paragraph 5.3, Yokogawa shall indemnify the Licensee only by paying back the price amount of the Licensed Software which Yokogawa has received from the Licensee. THE FOREGOING PARAGRAPHS STATE THE ENTIRE LIABILITY OF YOKOGAWA AND ANY THIRD PARTY LICENSING THIRD PARTY SOFTWARE TO YOKOGAWA WITH RESPECT TO INFRINGEMENT OF THE INTELLECTUAL PROPERTY RIGHTS INCLUDING BUT NOT LIMITED TO, PATENT AND COPYRIGHT.

Article 6 (Liabilities)

- 6.1 If and when the Licensee should incur any damage relating to or arising out of the Licensed Software or service that Yokogawa has provided to the Licensee under the conditions herein due to a reason attributable to Yokogawa, Yokogawa shall take actions in accordance with this Agreement. However, in no event shall Yokogawa be liable or responsible for any special, incidental, consequential and/or indirect damage, whether in contract, warranty, tort, negligence, strict liability, or otherwise, including, without limitation, loss of operational profit or revenue, loss of use of the Licensed Software, or any associated products or equipment, cost of capital, loss or cost of interruption of the Licensee's business, substitute equipment, facilities or services, downtime costs, delays, and loss of business information, or claims of customers of Licensee or other third parties for such or other damages. Even if Yokogawa is liable or responsible for the damages attributable to Yokogawa and to the extent of this Article 6, Yokogawa's liability for the Licensee's damage shall not exceed the price amount of the Licensed Software or service fee which Yokogawa has received. Please note that Yokogawa shall be released or discharged from part or all of the liability under this Agreement if the Licensee modifies, remodels, combines with other software or products, or causes any deviation from the basic specifications or functional specifications, without Yokogawa's prior written consent.
- 6.2 All causes of action against Yokogawa arising out of or relating to this Agreement or the performance or breach hereof shall expire unless Yokogawa is notified of the claim within one (1) year of its occurrence.
- 6.3 In no event, regardless of cause, shall Yokogawa assume responsibility for or be liable for penalties or penalty clauses in any contracts between the Licensee and its customers.

Article 7 (Limit of Export)

Unless otherwise agreed by Yokogawa, the Licensee shall not directly or indirectly export or transfer the Licensed Software to any countries other than those where Yokogawa permits export in advance.

Article 8 (Term)

This Agreement shall become effective on the date when the Licensee receives the Licensed Software and continues in effect unless or until terminated as provided herein, or the Licensee ceases using the Licensed Software by itself or with Yokogawa's thirty (30) days prior written notice to the Licensee.

Article 9 (Injunction for Use)

During the term of this Agreement, Yokogawa may, at its own discretion, demand injunction against the Licensee in case that Yokogawa deems that the Licensed Software is used improperly or under severer environments other than those where Yokogawa has first approved, or any other condition which Yokogawa may not permit.

Article 10 (Termination)

Yokogawa, at its sole discretion, may terminate this Agreement without any notice or reminder to the Licensee if the Licensee violates or fails to perform this Agreement. However, Articles 5, 6, and 11 shall survive even after the termination.

Article 11 (Jurisdiction)

Any dispute, controversies, or differences between the parties hereto as to interpretation or execution of this Agreement shall be resolved amicably through negotiation between the parties upon the basis of mutual trust. Should the parties fail to agree within ninety (90) days after notice from one of the parties to the other, both parties hereby irrevocably submit to the exclusive jurisdiction of the Tokyo District Court (main office) in Japan for settlement of the dispute.

Article 12 (Governing Law)

This Agreement shall be governed by and construed in accordance with the laws of Japan. The Licensee expressly agrees to waive absolutely and irrevocably and to the fullest extent permissible under applicable law any rights against the laws of Japan which it may have pursuant to the Licensee's local law.

Article 13 (Severability)

In the event that any provision hereof is declared or found to be illegal by any court or tribunal of competent jurisdiction, such provision shall be null and void with respect to the jurisdiction of that court or tribunal and all the remaining provisions hereof shall remain in full force and effect.

How to Use this Manual

Structure of the Manual

This User's Manual consists of eleven chapters and an Index as described below. Please read Chapters one, six, nine, and ten to use DAQ 32 Plus Client Package.

Chapter	Title	Description
1	Before Operation	Describes the environmental conditions required from your PC to use this software (Windows version), as well as the installation method of the software.
2	Communications software	Describes how to operate Launcher software to start each DAQ 32 Plus software. Also explains the Project function to protect software settings.
3	Software Configurator	Describes how to make communication settings and how to specify the directory in which data are to be collected. It also describes how to confirm system configuration, and how to initialize settings.
4	Darwin Hardware Configurator	Describes how to make DARWIN hardware settings such as input range, alarm relay and initialization.
5	Logger Software	Describes how to operate the software to display measured data on the monitor screen, save it to a PC and print it out. Explains also how to save report data to the harddisk.
6	Viewer Software	Describes how to operate the software to monitor the collected data saved on the harddisk and convert it to various formats (ASCII etc.)
7	Tag Editor	Describes how to acquire, write, or set tags that are set with DARWIN hardware.
8	Calibration	Describes how to calibrate DARWIN hardware.
9	Remote Monitor	Describes data observation functions for a remote monitor connected to DARWIN hardware and a network.
10	File Utility	Describes how to divide or unite data logging files, and how data logging files and report files can be converted into Excel, ASCII, or Lotus 1-2-3 formats.
11	Troubleshooting	Describes what to do in case trouble occurs and provides a list of error messages with corrective actions.
Index		Terms used in this manual listed in alphabetical order.

Range of Descriptions Given in this Manual

This manual does not include basic instructions for Microsoft Windows 2000, Windows XP, and Windows Vista. For a description, refer to its User's Manual.

Conventions used in this Manual

- Unit
 - k: Denotes "1000." Example: 100 kHz
 - K: Denotes "1024." Example: 100 KB
 - M: Denotes "1024K." Example: 100 MB
 - G: Denotes "1024M." Example: 2 GB

Note

Make sure to read manual Notes (with Note as title, and between lines as in this example). They contain important information for operating DAQ 32 Plus software.

Contents

Terms and Conditions of the Software License.....	ii
How to Use this Manual.....	iv
Chapter 1 Before Operation	
1.1 DAQ 32 Plus/DAQ 32 Plus Client Package Introduction	1-1
1.2 Required PC Environment	1-4
1.3 Setting up DAQ 32 Plus/DAQ 32 Plus Client Package.....	1-5
1.4 Opening and Closing each Software	1-6
1.5 DA100 Functions	1-8
Chapter 2 Communication Software	
2.1 Launcher Software.....	2-1
2.2 Making Project Settings	2-2
2.3 Switching and Protecting Projects	2-4
2.4 Version and License Information	2-5
Chapter 3 Software Configurator	
3.1 Using Software Configurator.....	3-1
3.2 Network Settings.....	3-2
3.3 Communication Settings.....	3-4
3.4 Selecting a Directory to Save Data	3-5
3.5 System Reconstruction/Scan/Initialization	3-6
3.6 Confirming ROM Version and System Info	3-9
Chapter 4 DARWIN Hardware Configurator	
4.1 Using DARWIN Hardware Configurator.....	4-1
4.2 Loading Setting Data	4-3
4.3 Setting Input Range, Span, and Linear Scaling.....	4-5
4.4 Alarm Settings	4-11
4.5 Setting Moving Average and Filter	4-14
4.6 Recording-related Settings (DR Only)	4-15
4.7 Selecting Channels to Save (for DC100, and DR with FDD Option Only).....	4-18
4.8 Tag Settings (DC100 or DR Only).....	4-19
4.9 Making Settings Per Channel	4-20
4.10 Transmission Output Channel Assignment.....	4-22
4.11 Setting Math Channel Equations	4-23
4.12 Copying Channel Settings	4-25
4.13 Setting Constants	4-27
4.14 Event/Action, Match Time, and Group Settings	4-28
4.15 Setting Timers and Summer/Winter Time	4-33
4.16 Printing Settings (DR Only).....	4-35
4.17 Setting Messages (DC100, DR only).....	4-37
4.18 Setting the Writing Operation (DC100 Only).....	4-38
4.19 Setting A/D Converter Integration Time, Filter, and Scan Interval	4-41
4.20 Setting Alarm Interval, Hysteresis, and Alarm Display Hold	4-43
4.21 Setting Relay and Internal Switch Actions	4-44
4.22 Setting Burn-out, RJC, and (for DR Only) Recording Colors.....	4-45
4.23 Report Settings	4-46
4.24 Setting (TLOG) Math Setup, Temperature Unit, and (DC100 only) SCSI ID Number	4-48

4.25	Setting FUNC Key, and SET Key Operations (for DC100, and DR only)	4-50
4.26	Setting the Recording Format (DR only)	4-51
4.27	Memory-related Settings (DC100 only)	4-53
4.28	Setting Keylock, Display Update Interval, and Channel/Tag Display Indication (DC100/DR only)	4-55
4.29	System Configuration	4-56
4.30	Subunit and Module Configuration	4-57
4.31	Initializing Settings	4-58
4.32	Sending Setting Data	4-59
4.33	Saving Setting Data	4-60
4.34	Hardware Configurator Display Settings	4-61
4.35	Printing Settings	4-62
4.36	Activating Hardware Actions	4-63

Chapter 5 Logger Software

5.1	Operating Logger Software	5-1
5.2	Logging Configuration	5-2
5.3	Group Settings	5-5
5.4	Displaying Waveforms on the Monitor	5-8
5.5	Stopping or Pausing Monitor display	5-11
5.6	Changing Monitor Display	5-12
5.7	Cursor Measurement	5-16
5.8	Starting and Stopping Recording	5-17
5.9	Icon Display during Monitoring/Recording	5-18
5.10	Saving and Loading Setting Data	5-19
5.11	Setting Math Actions, Resetting Alarms, and Starting/Stopping Reports	5-20
5.12	Reloading DARWIN Hardware Settings	5-21
5.13	Checking Logging Status, and Printing Waveforms	5-22
5.14	Using the DDE Server	5-23
5.15	Using the Auto Processor	5-24
5.16	Using the Monitor Server	5-26

Chapter 6 Historical Viewer Software

6.1	Introducing Historical Viewer Software	6-1
6.2	Opening Files for Display	6-3
6.3	General Display Settings	6-5
6.4	Setting Zones and the Y-Axis Clip	6-8
6.5	Setting the Waveform Time Axis	6-10
6.6	Cursor Measurement	6-11
6.7	Using Cursors to Search for Alarms and Marks	6-13
6.8	Using Cursors for Statistical Calculations	6-14
6.9	Notepad Copying	6-15
6.10	Displaying Alarm Info	6-16
6.11	Selecting Channel, Tag No., or Tag Comment display	6-17
6.12	User Defined and Trigger Marks	6-18
6.13	Saving Display Conditions	6-20
6.14	Converting the Data Format	6-21
6.15	File Formats	6-24
6.16	Outputting Data Divided with Cursors	6-29
6.17	Printing Measurement Data	6-30
6.18	Displaying, Converting, and Printing Report Data	6-32

Chapter 7 Tag Editor		1
7.1 Operating Procedures for the Tag Editor	7-1	
7.2 Receiving Tag Data.....	7-2	2
7.3 Setting Tag Nos. and Tag Comments	7-3	
7.4 Saving Tag Data to a Tag File, Writing Tag Data to DC100/DR	7-4	
Chapter 8 Calibration		3
8.1 Operating Procedures on the Calibration Screen	8-1	
8.2 Auto Calibration	8-2	
8.3 Manual Calibration	8-4	4
8.4 Calibrating the Transmission Output Module (DA, DC only).....	8-6	
8.5 Saving Calibration Data	8-9	
Chapter 9 Remote Monitor Software		5
9.1 Operating the Remote Monitor	9-1	
9.2 Connecting the Host and Saving Connection Conditions	9-4	
9.3 Group Settings/Displaying and Changing the Monitor/Using Cursors	9-6	
9.4 Pausing or Exiting Monitor Display	9-8	6
Chapter 10 File Utility Software		7
10.1 Operating the File Utility software.....	10-1	
10.2 Merging Measurement Data Files.....	10-2	
10.3 Dividing Measurement Data Files	10-4	7
10.4 Converting the Data Format	10-8	
10.5 Restructuring Measurement Data Files	10-10	
Chapter 11 Troubleshooting		8
11.1 Troubleshooting	11-1	
11.2 Error Messages and Corrective Actions	11-2	9
Index		10
		11
		Index

1.1 DAQ 32 Plus/DAQ 32 Plus Client Package Introduction

DAQ 32 Plus

Data Acquisition Software 32 plus consists of so called 'Launcher' software and of seven kinds of software which will open when the 'launcher' icons are clicked. Those icons will automatically be displayed when you open the 'Launcher' software.

The seven kinds of software are:

- 1 Software Configurator
- 2 DARWIN Hardware Configurator
- 3 Logger
- 4 Historical Viewer
- 5 Tag Editor
- 6 Remote Monitor
- 7 File Utility

Launcher software

Launcher software serves to open the above seven kinds of software, to use the Project function, and to protect software settings. When you install Data Acquisition Software 32 Plus, the Launcher software, (4) Historical Viewer software, (6) Remote Monitor software and (7) File Utility software will automatically be saved in the Windows 'Program' file. If you have made changes in any of the five kinds of software ((1) through (5) above) and saved those, you can use Launcher software to open the software with changed conditions next time you use it. Software with such changed conditions saved will be referred to as a 'Project.' 'Project function' is the name used for saving and opening Projects. The Project function is useful if you want to use Historical Viewer to observe DA100/DC100/DR measurement data on only one PC with a number of people. It enables you to observe waveforms without influencing someone else's settings.

1 Software Configurator

Enables you to make operation settings to the software. There are four setting displays.

Communications

Used to select a directory to save logging data to, and to make several communication settings between DA100/DC100/DR hardware and software.

Diagnostic

Used to make the necessary system configurations when using your DA100/DC100/DR for the first time, or when changing modules attached to a unit.

Calibration

Used to calibrate DA100/DC100/DR.

Network

Used to set IP address, Subnet Mask, and the Default Gateway of DA100/DC100/DR.

2 DARWIN Hardware Configurator

Enables you to make settings to the DA100/DC100/DR. Settings differ for each device. The hardware setting data can be saved to a PC.

Three kinds of data can serve as basis for further settings:

- Data earlier saved to a PC harddisk or to a floppydisk from the DA100/DC100/DR.
- Data settings as they remained when Hardware Configurator was last closed.
- Data settings of a directly PC-connected DA100/DC100/DR.

3 Logger

Enables you to display DA100/DC100/DR measurement and calculated Math data on your PC's monitor, and save measurement, calculated Math and report data to its harddisk. Allows you to set the interval for saving data, and for display renewal.

- Saving measurement data can be selected to start either,
 - immediately, or,
 - at a fixed time.
- Saving measurement data can be selected to end either,
 - immediately, or,
 - at a fixed time, or,
 - after a fixed data number has been reached.
- Report data will be saved when created by DA100, DC100, or DR.

Logger itself can make daily report files.

On your PC you can display the following monitors:

Alarm monitor

Displays the alarm condition of each channel. Useful as alarm monitor.

Trend monitor

Displays both measurement and computed waveforms. Useful for trend observation.

Color monitor

Displays measurement and computed data in selected color. Useful for monitoring trends for all measurement and computed data.

Meter monitor

Analog display of measurement and computed data. Depending on the aim of your observation, choose either a bargraph, meter, or thermometer monitor.

Numeric monitor

Displays numeric values of both measurement and computed waveforms. Useful when reading a large number of values at the same time.

Monitor settings can be connected by clicking the Link button.

An auto-processor automatically converts data logging and report files into Excel/ASCII/Lotus 1-2-3 formats. Report files are automatically printed.

The monitor server that supplies network-connected personal computers with data, is activated with Logger software.

4 Historical Viewer

Using Historical Viewer you can use the following 3 kinds of data to monitor waveforms, numerical values, etc. on a PC screen, or to print them out.

- Measurement data saved to a harddisk using Logger software.
- Measurement data from earlier obtained software for DARWIN instruments (DOS or Windows).
- Measurement data saved directly to a floppydisk from a DR/DC100.

It is possible to use a cursor to read the values of data on display, or make calculations with selected data.

Data can be converted to Excel/ASCII/Lotus 1-2-3 formats, and then saved.

Report data can be displayed, printed, and their formats can be converted.

5 Tag Editor

Tag stands for an optional character string (such as a terminal or signal name) used to distinguish waveforms in stead of graph and channel numbers. Use the 16 character 'Tag Comment' or the 8 character 'Tag No.' For Logger or Historical Viewer software, the Tags will be displayed instead of the channel number. It is possible to receive tag settings from or send them to a DR/DC100. Tag settings are not possible for the DA100.

Remote Monitor software

The Remote Monitor function is used to observe DARWIN data with a personal computer connected to the host through a network. Also, using Gate software applications, you can use the DX100P/DX200P, WT series instruments, or DAQ32Plus to acquire or monitor data using the Remote Monitor from other devices that are not directly compatible, including Yokogawa or other manufacturer's measuring instruments and OPC servers (DCS and PLC etc.). It is possible to display the same monitors as for Logger software: an Alarm Monitor, Trend Monitor, Color Graph Monitor, Digital Monitor, and a Meter Monitor.

An Ethernet port is required for the PC (host/remote monitor), and Windows TCP/IP protocol must be installed.

Furthermore, for the host it is necessary that DAQ 32 Plus Logger software is communicating and that the monitor server is operating.

File Utility software

Allows you to create files by merging or dividing existing measurement data files. Also used to convert measurement data and report data into Excel/ASCII/Lotus 1-2-3 formats. Functions and object files are as follows:

Merging Measurement Data Files (Merge): Used to merge continuous files into a new file.

- For measurement data files created with DAQ 32 R9 or later/DAQ 32 Plus R9 or later.
- For measurement data files being merged or divided with File Utility.

Dividing Measurement Data Files (Divide): Used to divide one file into multiple files.

- For measurement data files created with DAQ 32 R9 or later/DAQ 32 Plus R9 or later.
- For measurement data files created with software of earlier purchased versions of the DARWIN series (DOS, or Windows).
- For measurement data files created with DR/DC100.
- For measurement data files being merged or divided with File Utility.

Converting Data (Convert): Used to convert data into Excel/ASCII/Lotus 1-2-3 formats.

- For measurement data files created with DAQ 32 R9 or later/DAQ 32 Plus R9 or later.
- For measurement data files created with software of earlier purchased versions of the DARWIN series (DOS, or Windows).
- For measurement data files created with DR/DC100.
- For report files created with DA/DR/DC100 with report options (/M3).

Restructuring Files (Restruct): Used to merge continuous files into a new file and divide them with a new condition

- For measurement data files created with DAQ 32 R9 or later/DAQ 32 Plus R9 or later.
- For measurement data files being merged or divided with File Utility.

DAQ 32 Plus Client Package

DAQ 32 Plus Client Package consists of three kinds of software.

- Remote Monitor software
- Viewer software
- File Utility software

Operation for each software is equal to DAQ 32 Plus. For details please refer to the explanation for DAQ 32 Plus.

1.2 Required PC Environment

Operating System

Run DAQWORX under any of the following operating systems.

- Windows 2000 Professional SP4
- Windows XP Home Edition SP2
- Windows XP Professional SP2 (excluding Windows XP Professional x64 Edition)
- Windows Vista Home Premium (excluding the 64-bit edition)
- Windows Vista Business (excluding the 64-bit edition)

The language displayed by the software under different language versions of the OS are as follows.

OS Language	Software Language
Japanese	Japanese
German	German
French	French
Chinese	Chinese
Other	English

File System

NTFS is recommended. With FAT32, the number of files that can be saved in a single folder is much smaller. If the limit is reached and additional files cannot be saved, the software will not function normally. To prevent this, please periodically stop recording by the software and move the data to a different folder.

Hardware

PC

A PC that runs one of the OS above, and that meets the following CPU and memory requirements.

When Using Windows 2000 or Windows XP

Pentium 4, 1.6 GHz or faster
512 MB or more of memory

When Using Windows Vista

Pentium 4, 3 GHz or faster
2 GB or more of memory

Hard Disk

Free disk space: 200 MB or more (more may be required depending on the amount of data to be acquired)

CD-ROM Drive (for Use during Installation)

Printer, printer driver

Supported by the OS.

Monitor

When Using Windows 2000 or Windows XP

A monitor supported by the OS of 1024 × 768 dpi or higher and 65,536 colors or more.

When Using Windows Vista

A video card recommended for use with Vista and a monitor supported by the OS of 1024 × 768 dpi or higher and 65,536 colors or more.

Mouse and Keyboard

A mouse and keyboard supported by the OS

Communication board

GP-IB: GP-IB interface board (National Instruments; AT-GPIB/TNT, PCI-GPIB, GPIB-98 Turbo).

RS-232-C/RS-422-A/RS-485: Compatible only with a built-in COM port. For RS-422-A/RS-485 communication, connect a converter to the RS-232 port.

Ethernet : An Ethernet port is required for the PC. Windows TCP/IP service must be installed.

1.3 Setting up DAQ 32 Plus/DAQ 32 Plus Client Package

DAQ 32 Plus and DAQ 32 Plus Client Package software is available on both CD-ROM. Refer to CD-ROM setup below to setup the software. Make sure you have a serial number for the software beforehand. The serial number is on the CD-ROM case. Be aware that to start DAQ 32 Plus, and DAQ 32 Plus Client Package, different serial numbers are required.

DAQ 32 Plus

CD-ROM setup

- 1 Start up either Windows 2000 or Windows XP on your PC.
- 2 Insert the software CD-ROM in the CD-ROM drive.
- 3 Double-click the CD-ROM icon on My Computer. An English and a Japanese folder will appear.
- 4 If you open the English folder you will find a DAQ 32 Plus, and DAQ 32 Plus Client folder.
- 5 Open the required folder, then open the Disk 1 folder, and the below box appears.

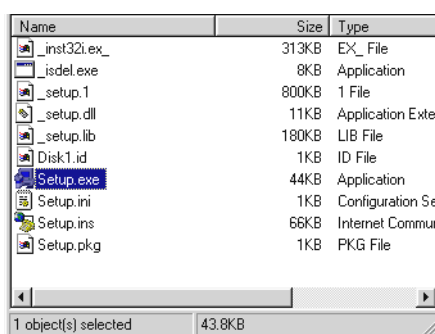

- 6 After double-clicking the setup.exe file the software will be executed. Wait and follow further instructions on the screen.

Note

- Before installing, it is recommended to deactivate virus busters.
- After installing is finished, the below software will be registered in the Start menu.
DAQ 32 Plus: Launcher, Viewer, Remote Monitor, File Utility
DAQ 32 Plus Client Package: Viewer, Remote Monitor, File Utility
- Make sure to install DAQ 32, DAQ 32 Plus, and DAQ 32 Plus Client Package in separate directories.
- Setting made with DAQ 32 can also be used for DAQ 32 Plus by copying the User and System folders of DAQ 32 to the directory in which you installed DAQ 32 Plus.
- Only reinstall DAQ 32 Plus after uninstalling the software in the below fashion.
- Uninstalling DAQ 32 Plus:
 - 1 Open Start menu > Settings > Control Panel > Add/Remove Programs.
 - 2 Please make a backup in a separate directory of the following important files:
 - All files of the data directories
 - All files with extensions .ast, .rst, .cst, .pnl, .set, .txt, for every project.
 - 3 Remove files created after DAQ 32 Plus was installed (left-over data files or subdirectories) using explorer.
- Don't set time zones using the Windows system autoexec.bat. (Place the REM command before commands like TZ=GMT0 for autoexec.bat.) To set time zones select the required time zone in the Windows OS Date/Time Properties setting screen (Start Menu > Settings > Control Panel > Date/Time), and check the "Automatically adjust clock for daylight saving changes" checkbox.
- In the Windows OS Date/Time Properties setting screen (Start Menu > Settings > Control Panel > Date/Time) always make sure to check the "Automatically adjust clock for daylight saving changes" checkbox, even if you do not wish to use daylight saving changes for DAQ 32 plus software. If you don't check the setting, errors may occur for the DARWIN Daylight Saving Time function.

1.4 Opening and Closing each Software

Opening DAQ 32 Plus Software

- 1 Select from the Start Menu, Program > YOKOGAWA DAQWORX > DAQ 32 Plus > Launcher.

When the Launcher software is activated, the below Launcher buttons will appear in the top of your screen. From the left to the right use the Menu button, Logger button, Historical Viewer button, File Utility button, Remote Monitor button, DARWIN hardware configuration button, Software configuration button, and Tag Editor button.

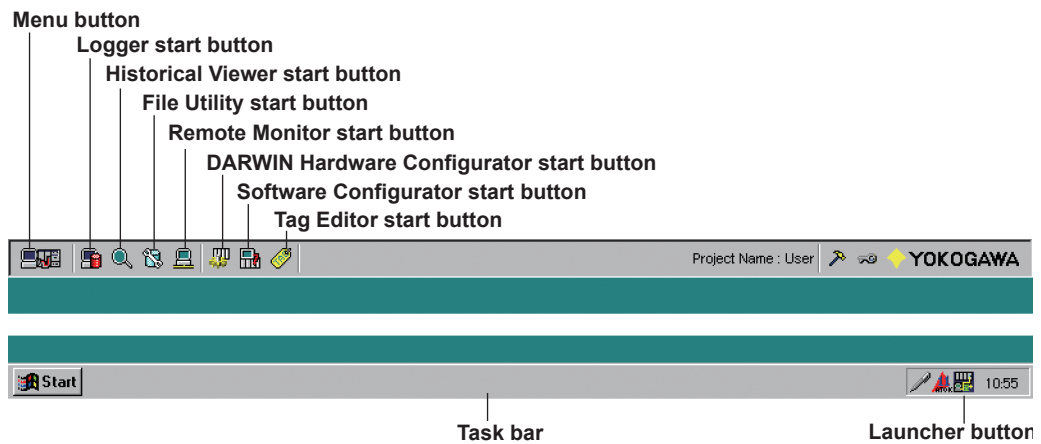

- 2 Open the desired software by clicking its Launcher button. You can also select the software after right-clicking the DAQ 32 plus icon on the taskbar (see below).

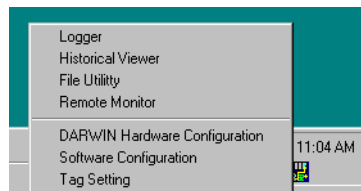

Note

- To simultaneously open several Historical Viewer screens, open Historical Viewer by selecting from the Start Menu, Program > YOKOGAWA DAQWORX > DAQ 32 Plus > Historical Viewer.
When Historical Viewer is opened like this, data which are actively being recorded with Logger software cannot be viewed.
- Software which can be activated simultaneously are Logger software, Historical Viewer, File Utility software, Remote Monitor software, and DARWIN hardware configuration software. Tag Editor software can be simultaneously used with Historical Viewer/ File Utility software/ Remote Monitor software. Remote Monitor software, and Software configuration software, can also be used simultaneously. Other software combinations can't be activated simultaneously.
First exit the non-matching software to activate the launcher icons for other software.
- When using a DC100 or DR for the first time, make sure to configure the devices with the actual device. After this initial configuration you can use DAQ 32 Plus software, to make configurations.

Opening DAQ 32 Plus Client Package software

- 1 Select from the Start Menu, Program > YOKOGAWA DAQWORX > DAQ 32 Plus Client. Then open Historical Viewer, File Utility software, or Remote Monitor software.

Note

- Historical Viewer, File Utility software, and Remote Monitor software can be opened simultaneously.
- To simultaneously open several Historical Viewer screens, open Historical Viewer by selecting from the Start Menu, Program > DAQ 32 Plus Client > Historical Viewer. When Historical Viewer is opened like this, data which are actively being recorded with Logger software cannot be viewed.

Closing DAQ 32 Plus software

To close one of the seven software programs, click the close button, or select File > Exit. To close the Launcher, first make sure all software programs are closed. Then, click the Menu button and select Exit, or click the DAQ 32 Plus icon on the taskbar, and select Exit. Closing the Launcher will also close the DAQ 32 Plus software.

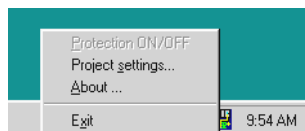
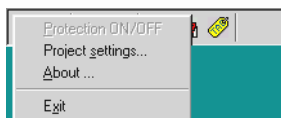

Closing DAQ 32 Plus Client Package software

Closing Remote Monitor software

- 1 Click File > Disconnect.
- 2 Click OK when asked to reconfirm.
- 3 Select File > Exit, or close the Remote Monitor window.

Closing Historical Viewer, or File Utility software

- 1 Select File > Exit.

1.5 DA100 Functions

Below instructions are valid for DA 100 only. For DC100, and DR functions, please refer to their User's Manuals.

Input Types

- **DC voltage**
This input type can be selected from 20mV, 60mV, 200mV, 2V, 6V, 20V and 50V. Refer to chapter 14 for the measurement range of each setting.
- **Thermocouple (TC)**
This input type can be selected from R, S, B, K, E, J, T, N, W, L, U and KP (KPVsAu7Fe). Refer to chapter 14 for the measurement range of each setting.
- **RTD (resistance temperature detector)**
This input type can be selected from PT1 (Pt100 1mA), PT2 (Pt100 2mA), JPT1 (JPt100 1mA), JPT2 (JPt100 2mA), PT50 (Pt50 2mA), NI1 (Ni100 1mA SAMA), NI2 (Ni100 1mA DIN), NI3 (Ni120 1mA), CU1 (Cu10 GE), CU2 (Cu10 L&N), CU3 (Cu10 WEED), CU4 (Cu10 BAILEY), PT1S (Pt100 1mA high resolution), PT2S (Pt100 2mA high resolution), JPT1S (JPt100 1mA high resolution), JPT2S (JPt100 2mA high resolution) and J263B (J263*B).
- **DI (voltage level: LEVL; contact:CONT)**
This input type can be selected from LEVL and CONT.
In case of LEVL, a voltage of less than approx. 2.4 V will be recognized as 0 (OFF), whereas a voltage of approx. 2.4 V or more (max. allowable voltage is up to ± 60 VDC) will be recognized as 1 (ON).
For CONT, an open, externally connected contact to which no voltage is applied, will be recognized as 0 (OFF), whereas a closed contact will be recognized as 1 (ON).
- **DELTA (difference between channels)**
Computation can be done only in the same unit. Destination channels should lie within the first channel No. to the last channel No. range. The number of the reference channel (REF) should be lower than the number of the destination channels. The default setting for the reference channel is 01.
The type of input and the measuring range in the destination channel are the same as for the reference channel. After setting the DELTA (difference between channels), if you attempted to change the type of input and the measuring range, setting the difference between channels is released, thereby the type of input and the measuring range in the destination channel are returned to their original settings, and the span is returned to its initial value.
- **mA (DC current, mA input module)**
This input can be set only for mA input channels. The measuring range is -20 mA to 20 mA.

- **Scale/span (SCALE)**

For VOLT, TC, RTD, DI, mA, AC and STRAIN, scale conversion is possible. Scale conversion is to convert measured values into values (physical values) of the system of units suitable for the application. The values obtained by converting the predetermined lower limit and upper limit values for span into physical value for the application will be used as the lower limit and upper limit values for scale. The unit for scale-converted values can be set using six characters.

Also, the scaling display mode/span of PULSE is set on the range screen. The span is the lower/upper limits of pulse count/ON time.

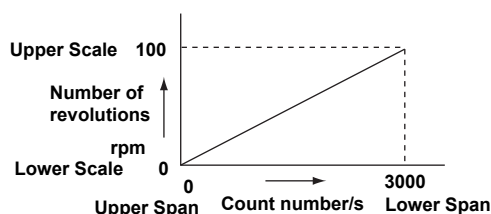

Setting the measurement range

Relationship between input type, measurement range and measurable range is given below.

- **DC voltage input (VOLT)**

Measurement Range	Display	Measurable Range
20mV	20mV	-20.000 to 20.000mV
60mV	60mV	-60.00 to 60.00mV
200mV	200mV	-200.00 to 200.00mV
2V	2V	-2.0000 to 2.0000V
6V	6V	-6.000 to 6.000V
20V	20V	-20.000 to 20.000V
50V	50V	-50.00 to 50.00V

- **Thermocouple (TC)**

TC Type	Display	Measurable Range
R	Type R	0.0 to 1760.0°C
S	Type S	0.0 to 1760.0°C
B*	Type B	0.0 to 1820.0°C
K	Type K	-200.0 to 1370.0°C
E	Type E	-200.0 to 800.0°C
J	Type J	-200.0 to 1100.0°C
T	Type T	-200.0 to 400.0°C
N	Type N	0.0 to 1300.0°C
W	Type W	0.0 to 2315.0°C
L	Type L	-200.0 to 900.0°C
U	Type U	-200.0 to 400.0°C
KpAu7Fe	KP	0.0 to 300.0K

* Guaranteed accuracy range Type-B 400.0 to 1820.0°C

• **Resistance temperature detector (RTD)**

RTD Type	Display	Measurable Range
Pt100:1mA	PT1	-200.0 to 600.0°C
Pt100:2mA	PT2	-200.0 to 250.0°C
JPt100:1mA _J	JPT1	-200.0 to 550.0°C
JPt100: 2mA _J	JPT2	-200.0 to 250.0°C
Pt50: 2mA _J	PT50	-200.0 to 550.0°C
Ni100:1mA-S ^{*1}	NI1	-200.0 to 250.0°C
Ni100:1mA-D ^{*2}	NI2	-60.0 to 180.0°C
Ni120:1mA ^{*3}	NI3	-70.0 to 200.0°C
Cu10: GE ^{*4}	CU1	-200.0 to 300.0°C
Cu10: L&N ^{*4}	CU2	-200.0 to 300.0°C
Cu10: WEED ^{*4}	CU3	-200.0 to 300.0°C
Cu10: BAILEY ^{*4}	CU4	-200.0 to 300.0°C
Pt100:1mA-H	PT1S	-140.00 to 150.00°C
Pt100: 2mA-H	PT2S	-70.00 to 70.00°C
JPt100:1mA-H	JPT1S	-140.00 to 150.00°C
JPt100: 2mA-H	JPT2S	-70.00 to 70.00°C
J263*B	J263B	-0.0 to 300.0K

*1 RTD (SAMA)

*2 RTD (DIN)

*3 RTD (McGROW EDISON COMPANY)

*4 RTD (Cuid)

Guaranteed accuracy range	Cu10: GE	-84.4 to 170.0°C
	Cu10: L&N	-75.0 to 150.0°C
	Cu10: WEED	-20.0 to 250.0°C
	Cu10: BAILEY	-20.0 to 250.0°C

• **Contact point (DI)**

Input Type	Display	Measurable Range
VOLT	LEVL	0 to 1 ^{*1}
CONTACT	CONT	0 to 1 ^{*2}

*1 OFF if below 2.4V, ON if above 2.4V

*2 Contact point ON/OFF

• **mA input (mA)**

Measurement Range	Display	Measurable Range
20mA	20mA	-20.000 to 20.000mA

• **Pulse input (PULSE)**

Measurement Range	Measurable Range
RATE	Determine the count number during 1s interval.
GATE	Determine the most occurring state, ON or OFF, during 1s interval.

• **Power monitor (AC)**

Input Range	Display
250V-0.5A	250V-0.5A
250V-5A	250V-5A
25V-0.5A	25V-0.5A
25V-5A	250V-5A

• **Strain input (STRAIN)**

Measurement Range	Display	Measurable Range
2k	2k	-2000.0 to 2000.0µε
20k	20k	-20000 to 20000µε
200k	200k	-20000 to 20000µε

Input Related Functions

- **Remote RJC*(RRJC) ← Can be selected only with optional math function (/M1 option)**

In measuring temperature with thermocouples within the same unit, when the item to be measured is located at a great distance, you can setup relay terminals near the item, measure the temperature of the relay terminal section using thermocouples (reference channel), and use the resultant value as the reference junction compensation value for the temperature measurement. By connecting a copper wire between the relay terminal and input terminal of the input module, and a thermocouple between the DUT and relay terminal, you can measure the temperature of the DUT without the need for a large amount of expensive thermocouples.

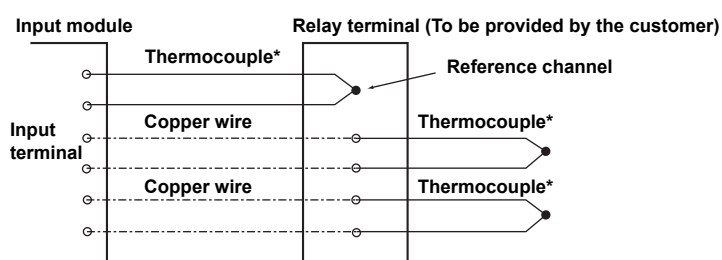

* Please use the same type of thermocouple.

Measurement period

The measurement period applies to all channels. It can be selected from 0.5, 1, 2, 3, 4, 5, 6, 10, 12, 15, 20, 30 or 60 seconds. However, the settable minimum measurement period varies as shown below according to the filter ON/OFF setting, type of input module and A/D integral time.

Input module	Integral time : 50/60Hz		Integral time : 100ms	
	Filter OFF	Filter ON	Filter OFF	Filter ON
10CH model	0.5s	3s	4s	12s
20CH model	2s	4s	5s	15s
30CH model	2s	4s	6s	20s

A/D integral time

Set the A/D integral time to 100 ms to maximize the noise elimination effect. To shorten calculation time, select 50Hz, 60Hz or AUTO (50/60Hz switching automatically). The settable minimum measurement period varies, as shown below according to the A/D integral time, filter settings and the number of input module channels.

- Integral time: 50/60Hz

Input module	Filter OFF	Filter ON
10CH model	0.5s	3s
20CH model	2s	4s
30CH model	2s	4s

- Integral time: 100ms

Input module	Filter OFF	Filter ON
10CH model	4s	12s
20CH model	5s	15s
30CH model	6s	20s

Input filter

The filter can be turned ON and OFF to reduce normal mode noise. Effects on normal mode noise are shown below (theoretical values).

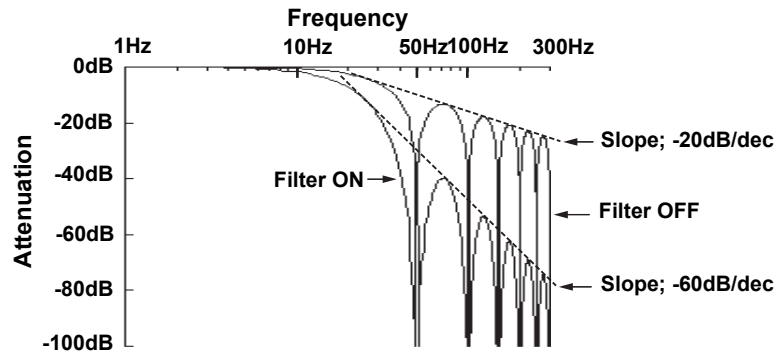

Moving average

A moving average value for the 2 to 64 latest measured values can be calculated. Use of the moving average function suppresses fluctuation of input signals, thus resulting in smooth waveforms.

For the first sampling following designation of the moving average function, the specified number of data sets are not acquired, thus all the data are considered to be the first sampled data for moving average.

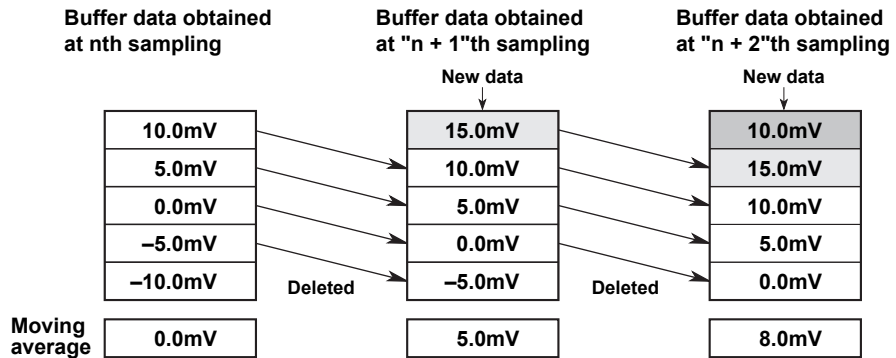

Note

Setting moving average on the pulse input channel doesn't effect the measured value.

Alarm setting

The following six types of alarm are provided for each channel.

Up to four alarm values (levels) can be designated for each channel. For DI input, alarm values are set to "1" (ON) or "0" (OFF). If an alarm value is designated, an alarm signal will be output from the alarm output relay when the measured value reaches this alarm value.

- **H: Upper limit alarm**
Triggers an alarm when the measured value exceeds the designated alarm value.
- **L: Lower limit alarm**
Triggers an alarm when the measured value drops below the designated alarm value.
- **RH: Rate-of-change upper limit alarm**
Triggers an alarm when positive change of measured value exceeds the specified value within the specified interval.

- RL: Rate-of-change lower limit alarm**
 Triggers an alarm when negative change of measured value exceeds the specified value within the specified interval.
- DH: Delta high limit alarm**
 This alarm is applicable only for channels for which Delta is selected. Triggers an alarm when the difference of measured values between two channels exceeds the specified value.
- DL: Delta low limit alarm**
 This alarm is applicable only for channels for which Delta is selected. Triggers an alarm when the difference of measured values between two channels drops below the specified value.

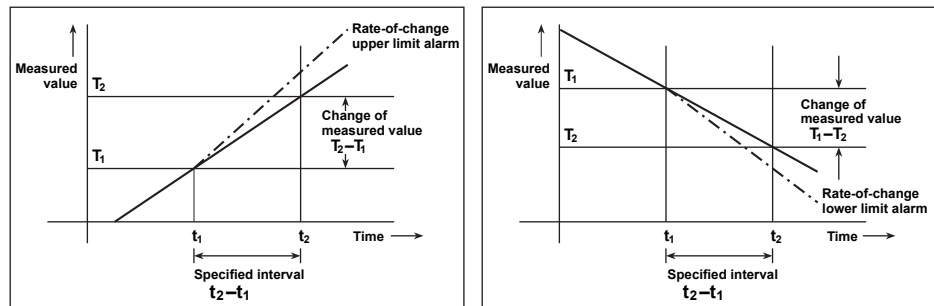

Note

- Alarm settings will be cleared in the following cases.
 The measurement mode/input type (VOLT, TC, ...) is changed.
 The measurement range is changed.
 The span or scaling value is changed (including change of the decimal point position) during scale conversion display mode.
 Channel No., input type or input range of the standard channel is changed during delta measurement mode.
- For pulse input channels and power monitor channels, "RH:rate-of-change upper limit alarm" / "RL: rate-of-change lower limit alarm" are not available.

Alarm hysteresis

A specified margin (hysteresis) can be added to the specified alarm level. (Common to all alarms).

Upper alarm limit (H)

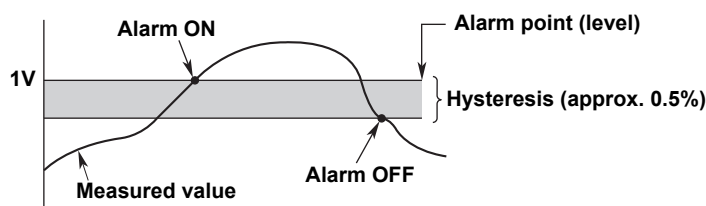

Lower alarm limit (L)

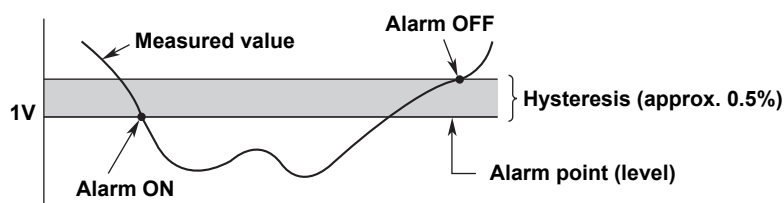

Alarm output relay energize/de-energize

The alarm output relay can be switched between energizing mode and de-energizing mode. If de-energizing mode is selected, the alarm relay can still be energized in the same way as when an alarm occurs, even if the power is turned OFF due to a power failure or other reasons.

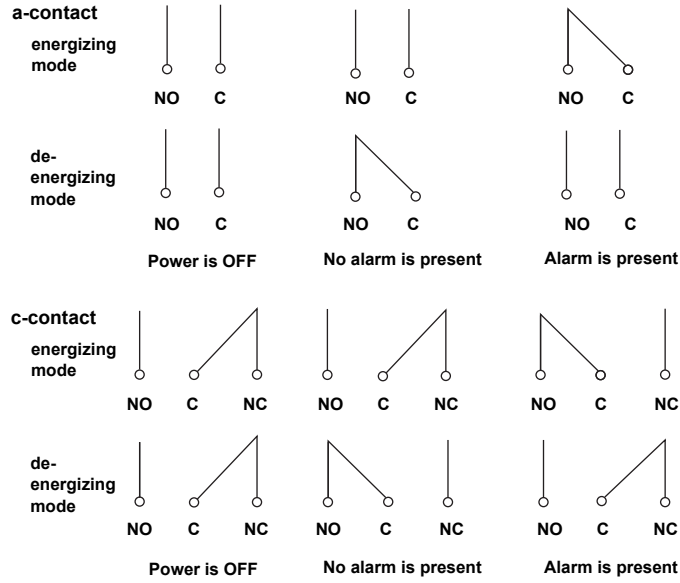

Alarm output relay AND/OR

If one alarm output relay is shared by more than two channels or alarm levels, the output method for the alarm output relay can be selected from the following two methods.

AND : Energizes the alarm relay when all the alarms occur simultaneously.

OR : Energizes the alarm relay when an alarm occurs in any of the channels or at any of the alarm levels.

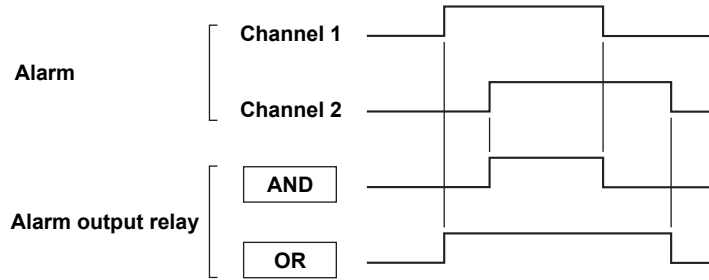

Note

The reflash relay is always used in OR mode.

Reflash alarm

In general, in cases where one alarm output relay is shared by more than two channels, no alarm signal will be issued if an alarm occurs in another channel or at another alarm level, once an alarm has occurred in one channel and the alarm signal has been issued. In this case, the alarm signal can be issued by designating the reflash output relay (designated by alarm setting) as the alarm output relay. Up to six relays can be designated as reflash relays.

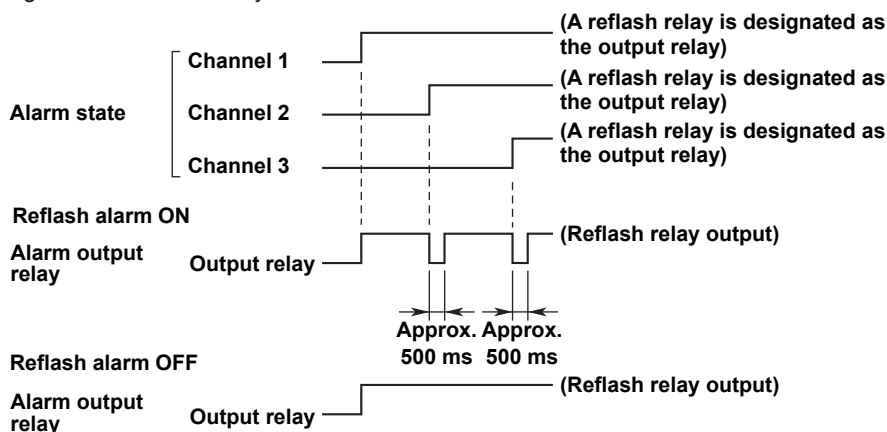

Alarm output relay hold/non-hold

Each alarm output relay can be switched to the hold mode or non-hold mode.

Non-hold mode:

Each alarm output relay is activated according to its alarm ON/OFF state.

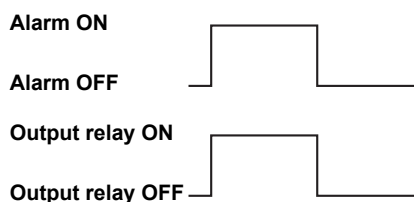

Hold mode:

Once an alarm occurs, the alarm output relay continues to be activated even if the alarm is turned OFF. To stop the alarm relay output, reset the alarm using a communication command. For a description of communications commands, see the GP-IB/RS232-C Interface User's Guide.

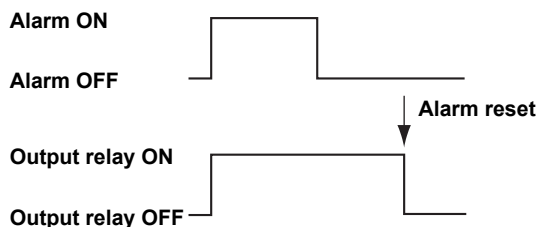

Event/Action (For DA100 with /M1 or /M3 option, or pulse input module, only)

A function in which the remote control signal input of the DI/DO module, alarm, or the timer setting is used to set a trigger (event), and using that trigger to execute various actions is called the event/action function.

Event

The following items can be set.

- Remote control signal input (REMOTE)
When the remote control signal of the selected number (same number as the terminal number) is inputted, it is detected as an event.
- Alarm (ALARM)
When even 1 alarm goes off, an event is detected. It can be reset with an action.
- Alarm output relay (RELAY)
When the selected alarm output relay switches ON, it is detected as an event.
- Timer (TIMER)
Event detection occurs every specified time interval. There are 2 ways to set the alarm as shown in the diagram below; Relative time setting and Absolute time setting . Six timers can be set, which are reset with an action.

Relative time setting

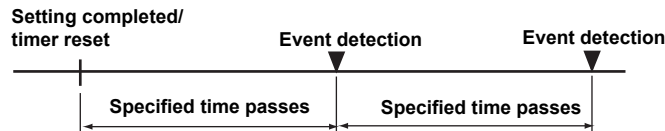

Absolute time setting

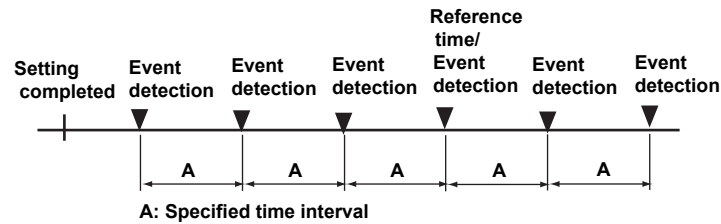

- Match time
Event occurs at the specified time.

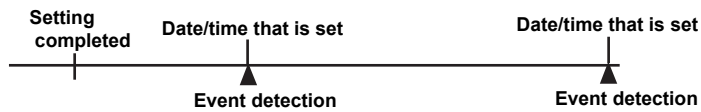

Event mode

If you want actions when an event is detected, select Edge. If you want to stop actions (MATH or REPORT) when an event occurs (such as remote control input OFF, alarm reset, and time reset), select Level.

Action

The following items can be selected as actions.

- Alarm reset
Reset all the alarms.
- Timer reset
All timers with relative time settings are reset.

- Math computation start/stop/clear/reset

Clear:

When issued during the computation, the measured data is reset before doing the first computation.

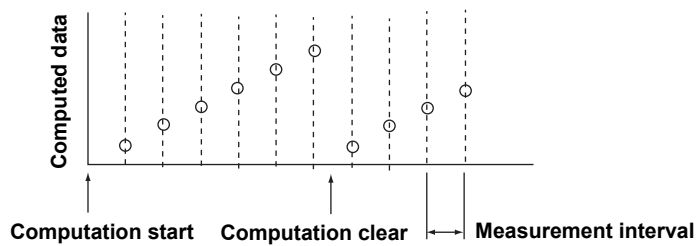

Reset:

When issued during the computation, the measured data is reset after doing the first computation.

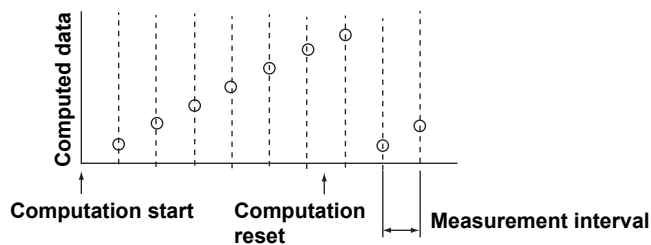

- Report start/stop

For models with Report option it is possible to start/stop reporting.

Computation (Uniquely for DA100 with /M1 option)

The DA100 can execute computations with the measured data of each input channel taken as a variable. The results can be displayed or saved. The following operators can be used for computation.

Basic operators

Type	Operator	Example	Description
Addition	+	001+002	To obtain the sum of the measured data of channel 001 and channel 002.
Subtraction	-	002-001	To obtain the difference of the measured data of channel 002 and channel 001.
Multiplication	*	003*K1	To multiply constant K1 to the measured data of channel 003.
Division	/	004/K2	To divide the measured data of channel 004 by constant K2.
Power	**	005**006	To take the power of measured data of channel 005 with the measured data of channel 006.
Absolute value	ABS()	ABS(001)	To obtain the absolute value of the measured data of channel 001.
Square root	SQR()	SQR(002)	To obtain the square root of the measured data of channel 002.
Common logarithm	LOG()	LOG(003)	To obtain the common logarithm of the measured data of channel 003.
Natural Logarithm	LN()	LN(004)	To obtain the natural logarithm of the measured data of channel 004.
Exponent	EXP()	EXP(005)	To make the measured data of channel 005 to be x and obtain e^x .

* +/- can be used as signs as in -(001).

Logical operators

Type	Operator	Example	Description
Logical product	AND	001AND002	when channel 001=0 and channel 002=0, "0." when channel 001=nonzero and channel 002=0, "0." when channel 001=0 and channel 002=nonzero, "0." when both channel 001 and channel 002 are nonzero, "1."
Logical sum	OR	001OR002	when channel 001=0 and channel 002=0, "0." when channel 001=nonzero and channel 002=0, "1." when channel 001=0 and channel 002=nonzero, "1." when both channel 001 and channel 002 are nonzero, "1."
Exclusive OR	XOR	001XOR002	when channel 001=0 and channel 002=0, "0." when channel 001=nonzero and channel 002=0, "1." when channel 001=0 and channel 002=nonzero, "1." when both channel 001 and channel 002 are nonzero, "0."
Logical negation	NOT	NOT001	when channel 001=0, "1." when channel 001=nonzero, "0."

Relational operators

Type	Operator	Example	Description
Equal	.EQ.	001.EQ.002	when channel 001 = channel 002, "1." when channel 001 ≠ channel 002, "0."
Not equal	.NE.	002.NE.001	when channel 001 ≠ channel 002, "1." when channel 001 = channel 002, "0."
Greater than	.GT.	003.GT.K1	when channel 003 > constant K1, "1." when channel 003 ≤ constant K1, "0."
Less than	.LT.	004.LT.K10	when channel 004 < constant K10, "1." when channel 004 ≥ constant K10, "0."
Greater than or equal to	.GE.	003.GE.K1	when channel 003 ≥ constant K1, "1." when channel 003 < constant K1, "0."
Less than or equal to	.LE.	004.LE.K10	when channel 004 ≤ constant K10, "1." when channel 004 > constant K10, "0."

Specified channel statistical operators

Type	Operator	Example	Description
Maximum value	TLOG. MAX()	TLOG. MAX(001)	To obtain the maximum value of the measured data of channel 001.
Minimum value	TLOG. MIN()	TLOG. MIN(002)	To obtain the minimum value of the measured data of channel 002.
Max-min value	TLOG. P-P()	TLOG. P-P(003)	To obtain the P-P value of the measured data of channel 003.
Total value	TLOG. SUM()	TLOG. SUM(004)	To obtain the total value of the measured data of channel 004.
Average value	TLOG. AVE()	TLOG. AVE(005)	To obtain the average value of the measured data of channel 005.
Integration value**	TLOG. PSUM()	TLOG. PSUM(001)	To obtain the integration value of the measured data of channel 001.

* Statistical computation of the measured data from the start of the statistical computation until it is stopped. When combining with each of the operators, MAX(), MIN(), P-P(), SUM(), and AVE(), the value that can be specified inside the () is limited to the input channel number or the computation channel number (see next page) (Example: TLOG.MAX(A01)).

** Effective only on pulse input channels. It can also be used by instruments without option /M1.

Statistical operators within the group

Type	Operator	Example	Description
Maximum value	CLOG. MAX()	CLOG. MAX(G01)	To obtain the maximum value of the measured data of group G01.
Minimum value	CLOG. MIN()	CLOG. MIN(G02)	To obtain the minimum value of the measured data of group G02.
Max-min value	CLOG. P-P()	CLOG. P-P(G03)	To obtain the P-P value of the measured data of group G03.
Total value	CLOG. SUM()	CLOG. SUM(G04)	To obtain the total value of the measured data of group G04.
Average value	CLOG. AVE()	CLOG. AVE(G05)	To obtain the average value of the measured data of group G05.

* Statistical computation of the measured data of the input channel within the same group measured at the same time every specified interval.

Special operators

Type	Operator	Example	Description
Previous	PRE()	PRE(001)	To obtain the previous measured data of channel 001 value*
Hold**	HOLD():	HOLD(001): TLOG. SUM(002)	When the measured value of channel 001 changes from 0 to a nonzero value, maintain the integrated value of the measured data of channel 002 while the measured value of channel 001 is nonzero.
Reset**	RESET():	RESET(001): TLOG. SUM(002)	When the channel 001 = nonzero, reset the integrated value of the measured data of channel 002

* Previously measured data or computed data. For computed data, the value is set to 0 when the computation is reset. At the start of the computation, if the computation was reset, the value is 0. If it was not reset, the value is the last value of the previous computation. The value that can be specified inside the() is limited to the input channel number (001 to 060) or the computation channel number (A01 to A60). Each computing equation can be used once.

** When specifying HOLD(A):B or RESET(A):B, A and B are channel numbers or computing equations. These can be used once in the beginning of the computing equation.

Math for PULSE input module

The operator is TLOG.PSUM(XXX) where XXX is the channel number. If your DA100 does not have the optional Math function (/M1 option), TLOG.PSUM(XXX) is the only operator available.

When the Range is set to "RATE" (momentary pulse count mode) the count number is integrated. When the Range is set to Gate (contact ON/OFF detection mode) the ON time is integrated. Because both values are integrated values of the measurement made every 1 s, the same value is held for a duration of 1 s when the measurement interval is set to 0.5 s.

The maximum count number or ON time is set with SPAN. The highest value that can be set for the maximum value is 99999999. The integration interval is set to relative time or absolute time by setting the event to timer in the event/action function. Also, action is set to timer reset.

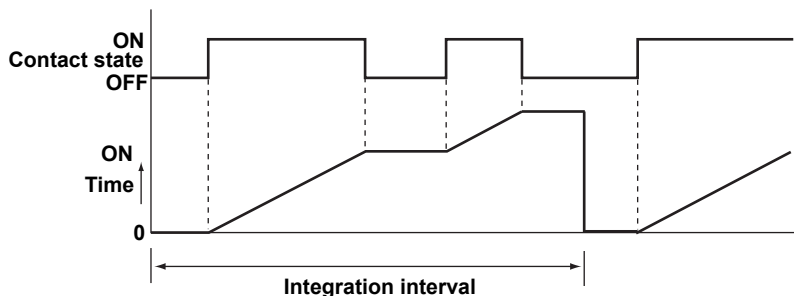

You can select whether to treat a result of the computational expression TLOG.PSUM (XXX) exceeding 99999999 as an overflow or to continue computing with the value following 99999999 reset to 0. Computing results from a separate calculation of TLOG.PSUM (XXX). If you set the computational expression as TLOG.PSUM (XXX)*K01(K01=100), the above action there are no changes even if the result of the calculation TLOG.PSUM (XXX)*K01 exceeds 99999999. If you choose to continue computing even if the result exceeds 99999999, the value subsequent to 99999999 is reset to 0.

For example, if the measured value is 4 after the computed result becomes 99999999, it is counted 0 > 1 > 2 > 3 and becomes 3, not reset to 0.

Computing equations are set according to the following rules:

The number of computing equations

Thirty computing equations for the stand-alone type and sixty for the expandable type can be set. Each computing equation is assigned a number. The numbers are A01 to A30 for the stand-alone type and A01 to A60 for the expandable type. These numbers are called computation channel numbers.

Data to be computed

- Measured data: Specified with channel numbers (example: 050).
- Computed data: Specified with computation channel numbers.
- Constants: 30 constants for the stand-alone type and 60 constants for the expanded type can be set. Each constant is expressed by a number from K01 to K60 (K01 to K30 for the stand-alone type).

Priority of operators

The priority of operators in a computing equation is as follows. The operators are placed in order from the highest priority.

Type	Operators
Function	ABS(), SQR(), LOG(), LN(), EXP(), MAX(), MIN(), P-P(), SUM(), AVE(), PRE(), HOLD():, RESET():, PSUM()
Power	**
Signs, logical negation	+, -, NOT
Multiplication, division	*, /
Addition, subtraction	+, -
Greater/less relation	.GT., .LT., .GE., .LE.
Equal/not equal relation	.EQ., .NE.
Logical product	AND
Logical sum, exclusive	OR, XOR

Range when computing

When the value exceeds ±10308 during the computation, a computation error (overflow) occurs.

Units in computing equations

In computations, measured data are handled as numbers without units. For example, if the measured data of channel 001 is 20 mV and the measured data of channel 002 is 20 V, the computed result of 001+002 becomes 40.

Limitations in computing equations

Multiple operators can be used in one computing equation. But, there are following limitations.

- The number of characters that can be used : 40 characters
- The total amount of channel numbers and constants: 16 (Computation error occurs when 16 is exceeded, and the computed result becomes +OVER or -OVER)
- Computation channel numbers: Computation channel numbers less than the current computation channel number can be used as variables within the computing equation. Example: A02=001+A01 Computation channel numbers greater than or equal to A03 can not be used in this computation.
- Statistical operators (TLOG. or CLOG.) can only be used once in one computing equation.

Math operation control

Math operation can be controlled using the data collection software, and by using the event/action function.

- Control using the data collection software.
You may use Math Start, Stop, Clear, or Clear & Start.

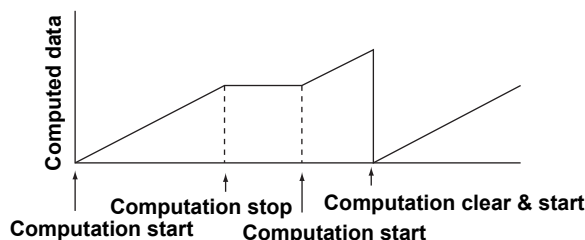

Some report Math functions (optional)

The DA calculates and processes an hour's, a day's or a month's worth of measurement or computation data into instantaneous values, averages and/or sums. The results can be delivered using the communication function.

Reports come in the following three types.

- Hourly report:
 - Reporting intervals ; Every hour (1:00, 2:00 . . . , 23:00, 24:00)
 - Computing data item ; An hour's average, maximum and minimum
 - An hour's sum and cumulative sum
 - Instantaneous value at the time of making the report
- Daily report:
 - Reporting intervals ; Every other day (preset time)
 - Computing data item ; A day's average, maximum and minimum
 - A day's sum and cumulative sum
 - Instantaneous value at the time of making the report
- Monthly report:
 - Reporting intervals ; Every other month (preset time)
 - Computing data item ; A month's average, maximum and minimum
 - A month's sum
 - Instantaneous value at the time of making the report

Putting the hourly, daily and monthly report ON or OFF

You can set reports to be made, separately, every hour, day or month. Daily and monthly reports may be set to either the standard output format (ON1) or the enhanced output format (ON2). Note that the enhanced format can only be set for either daily reports or monthly reports at a time.

Output Formats

Output formats can be set to standard or enhanced format. Hourly reports only have a standard format.

Standard format: Prints the results of computing configured on a report-channel basis.

Enhanced format:

- Daily reports: Results of computing configured on a report-channel basis plus information on instantaneous values given at each preset time.
- Monthly reports: Results of computing configured on a report-channel basis plus information on instantaneous values given simultaneously with the preset time for making each report.

Report Time

To set the time to make a report, define the day of the month within a 01-28 range and the time within a 00-23 range.

- Hourly reports:
The DA makes reports every whole hour (1:00, 2:00, . . . , 23:00, 24:00). For cumulative summation, it resets the cumulative sum at a preset time.
- Daily reports:
The DA makes reports at preset time(s). For cumulative summation, it resets the cumulative sum at a preset time and day.
- Monthly reports:
The DA makes reports at a preset time of a certain day of the month.

Report Channels

There are sixty report channels, from R01 to R60. You can assign either measuring channels or Math channels to each report channel. When making a report of computed Math data, start computing before starting a report.

Computing Types

Setting Parameter	Data Item for Computing
INST	Instantaneous value at the time of making report
AVE	Average, maximum and minimum over the computing period
SUM	Sum and cumulative sum over the computing period

Sum and Cumulative Sum

- Sum : The total sum over an hour for hourly reports, the sum over a day for daily reports or the sum over a month for monthly reports. The DA resets this value each time it makes any of these reports.
- Cumulative sum : The total sum up to the preset time to make a report in the case of hourly reports or the sum up to a preset time of the day to make a report in the case of daily reports. The DA resets this value at each preset time or at each preset time of the day for report making. The DA does not perform cumulative summation for monthly reports.

As an example, the following illustrates the process of summation and cumulative summation for hourly reports. The example shows a case where the preset reporting time is 8:00.

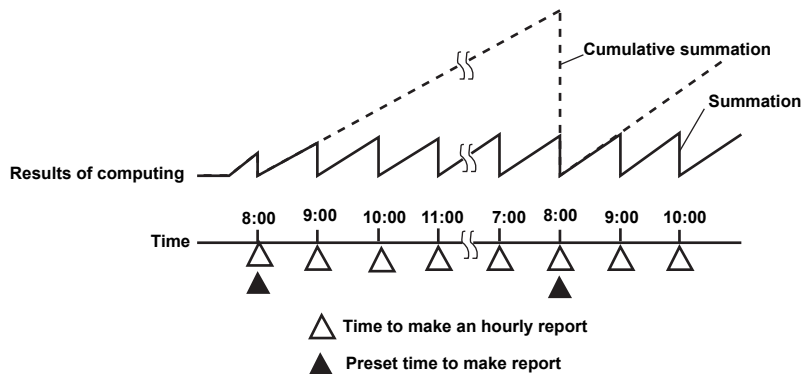

Unit of Summation (SUM UNIT)

Input data, such as the flowrate, with units in /sec, /min, /hour or /day, give results of computing different from their actual values, when simply summed. This occurs because the unit of such a data item differs from that of the measurement interval. In that case, you can take the output after having converted the unit of summation so it matches that of the input data item applied.

Unit of Input (Preset Unit)	Conversion Formula
INTVL (no conversion)	Σ (measured data values)
/sec	Σ (measured data values) \times measurement interval
/min	Σ (measured data values) \times measurement interval/60
/hour	Σ (measured data values) \times measurement interval/3600
/day	Σ (measured data values) \times measurement interval/86400

Start/Stop Reporting

Use the event/action functions to define reporting start/stop for the following events:

- Edge action : Define every event as an edge action to start or stop reporting.
- Level action : Use remote, alarm, relay signals as events to start or stop report making.
Reporting starts at the same time that any of these events occur.
Reporting stops when the event clears.

Note

- If you start report making, all reports created up to that point are reset.
- When report making is in progress, you cannot make changes to measurement channels, measuring ranges or dates and times, nor can you copy range information.
- If any computed data are included in your report making, let computing start first and then get report making started. If you fail to enable computing, the data in your reports will become meaningless because no change takes place in the computed data.
- If you want the start of computing and report making enabled at the same time, use the event/action functions to assign both of these instructions to the same event as actions.

Output Report

Report outputting can be started in communication.

Time Relationship Between the Report Start/Stop and Report Making

The following figure shows the time relationship between the report start / stop, and the reporting in progress.

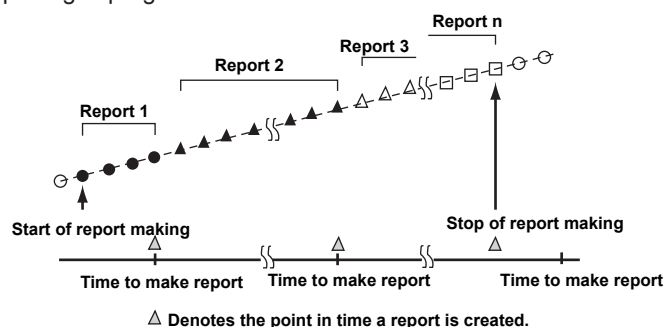

- Data items included in the first round of reporting after the report start are fewer in number than those included in the second and subsequent rounds of report making.
- If the time when data are sampled coincides with report stop, the DA samples the data before the report stop. The report created when the DA stops making reports thus includes those data.
- If the report start coincides with the time the report is created, the start precedes, thus, no report is created.

1.5 DA100 Functions

- If the time when data are sampled coincides with the report start, the data sampled at the same time report making started are included in first reporting round. The report created when the DA stops making reports thus includes those data.
- If you have defined timer and match-time signals as events using the event/action functions in order to let the report start match the actual reporting, data items included in the first reporting round will have one data item more than those included in the second or any subsequent reporting round.

Temporary measurement omissions

Measurement may not take place if the DA is loaded beyond its processing capability. If a measurement omission occurs, the DA compensates for the missing data with the data it measures immediately after recovering from the measurement omission (the data for the period with no measurement thus match those acquired immediately after recovering from the temporary measurement omission).

Power failures during reporting

The DA makes a report immediately after it recovers from the power failure and then stops reporting.

Computing results: The DA computes data measured up to the point immediately before the power failure.

Reporting time: The time when the power failure occurred.

Handling of faulty data

If data being computed contain any abnormalities, the DA treats the data as summarized in the following table.

Note that in the case of positive and negative overflows, minimum and maximum values are included in the computing.

Type of Faulty Data	Average	Minimum/ Maximum	Instantaneous	ValueSum
Positive overflow	Not computed	Computed	Takes faulty data as the computing result	Not computed
Negative overflow	Not computed	Computed	Takes faulty data as the computing result	Not computed
Channels included in measurement set to SKIP	Not computed	Not computed	Takes faulty data as the computing result	Not computed
No channel included in measurement	Not computed	Not computed	Takes faulty data as the computing result	Not computed
Error, power failure	Not computed	Not computed	Takes faulty data as the computing result	Not computed
Incapability of data output	Not computed	Not computed	Takes faulty data as the computing result	Not computed

2.1 Launcher Software

Launcher Software enables you to launch each DAQ 32 Plus software, use the Project Function, and to protect software settings.

Launching each DAQ 32 Plus software

Select from the Start menu, Programs > YOKOGAWA DAQWORX > DAQ 32 Plus > Launcher.

Software start buttons (see below) will be displayed automatically when Launcher software is opened. The seven kinds of software are Software Configurator, DARWIN Hardware Configurator, Logger, Historical Viewer, Tag Editor, Remote Monitor, and File Utility.

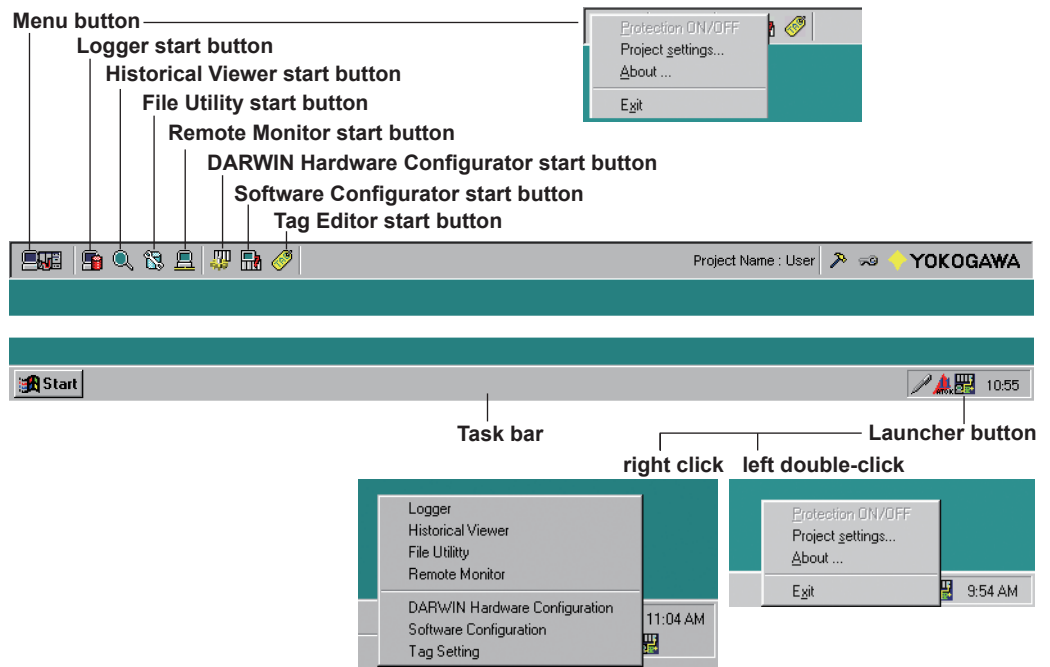

Project function

A Project is a saved group of DAQ 32 Plus software settings with changed conditions. Using the Project Function it is possible to open software which settings were changed earlier. In order to do this you must have saved the setting conditions you created earlier as a Project. The Project Function is useful if you want to observe DA100/DC100/DR measurement data on only one PC with a number of people. It enables one user to observe waveforms without influencing other people's settings. Note that you can only open a Project after you have closed other DAQ 32 Plus software.

Protection settings

Enables you to protect settings from getting erased. After a password is entered (in the Project Settings dialogbox), the toolbar will become pink to mark that protection is active.

Software version

To check software name, version, and license information click About... on the menu.

2.2 Making Project Settings

Saving a new Project

- 1 To open the Project Settings dialog box (see below) you should first close all DAQ 32 Plus software. Open the Project Settings dialogbox by clicking the Project Settings button (see below), or click the Menu button and select Project settings....

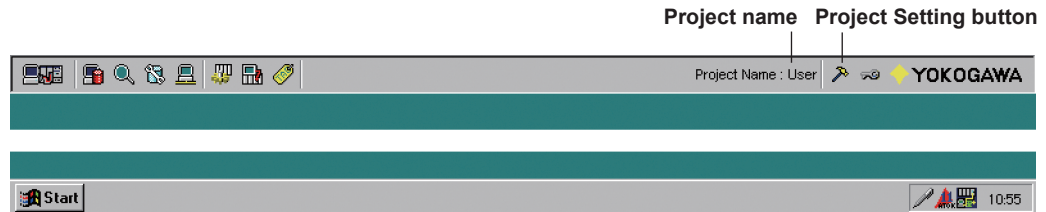

Project name, and overview of saved projects

Launcher position on PC screen

Select for auto-start monitoring and recording

Check to protect settings with a password

Check to use the keypad lock for DR and DC 100

The 'Project Settings' dialog box contains the following elements:

- Select Project:** A pull-down menu showing 'test1' and buttons for 'OK', 'Cancel', and 'Delete'.
- Launcher Position:** Radio buttons for 'Top', 'Bottom', 'Left', and 'Right'.
- Auto Startup:** Radio buttons for 'OFF', 'Monitor measurement data only', and 'Monitor and record measurement data'.
- Password Protection:** A checkbox for 'Activate' and a 'Change' button.
- DR/DC100 Keypad Lock:** A checkbox for 'Activate'.

Delete projects

Password setting

- 2 Select New project from the Select Project pull-down menu. The New Project dialog box opens.
- 3 Enter a name in the New Project dialog box, and click OK.
- 4 Select a place to position the Launcher menu on the screen: Top, bottom, left, or right.
- 5 Select Logger software to monitor measurement data only, to both monitor and record measurement data, or to display nothing.
- 6 Select whether you want to use the Password Protection function or not. If you check Activate, Project changes without first entering a password will become impossible.
- 7 Click the Change button to open the Password Setting dialog box. After you enter a password click OK. Click Cancel to invalidate the setting. Use the entered password to release the Project lock.
- 8 Check Activate if you want the Keypad of the DC100 / DR connected to your PC to be locked while Logger is operating (monitoring/recording).
- 9 After you have finished all settings, save them by clicking OK, or erase them by clicking delete. The Project Settings dialog box closes.

Changing/deleting Project settings

- 1 To open the Project Settings dialog box you should first close all DAQ 32 Plus software. Open the Project Settings dialogbox by clicking the Project Settings icon or click the Menu button and select Project settings... .
- 2 Select the Project you desire to change or delete from the Select Project pull-down menu.

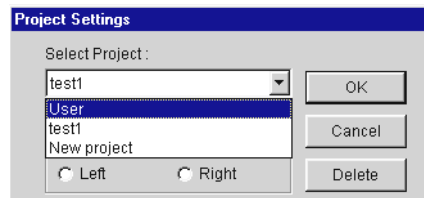

If the Password Protection wasn't activated the Project Settings dialogbox of the selected Project will appear. If Password Protection is active a dialog will first appear in which you should enter the password.

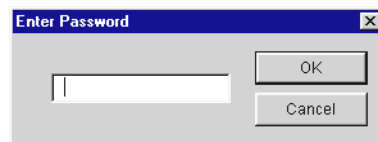

Click OK to open the selected Project.

- 3 To alter Project Settings just repeat step 4 to 9 above.
- 4 To erase Project Settings click Delete, and confirm or cancel deletion in the message box that appears.

Note

- One last Project cannot be deleted.
- One unprotected Project will always remain.

2.3 Switching and Protecting Projects

Switching Projects

- 1 Close all DAQ 32 Plus software of before switching to a new Project in the Project Settings dialog box. Open the Project Settings dialogbox by clicking the Project Settings button (see below) or click the Menu button and select Project settings...



- 2 Select the desired Project from the Select Project pull-down menu.

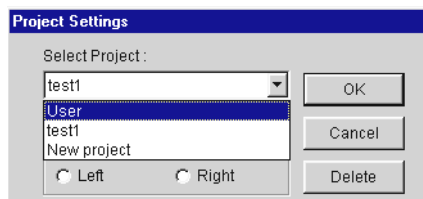

If the Password Protection hasn't been activated the Project Settings dialogbox of the selected Project will appear. If Password Protection is active a dialog will first appear in which you have to enter the password. Click OK to open the selected Project.

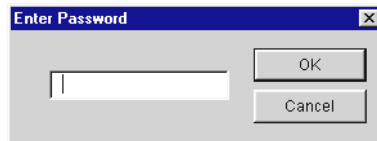

Protecting Projects

To prevent the currently used Project from being changed the Password Protection should first be activated. Read the last Section on how to activate the protection. After you activated the Password Protection lock Projects as described below.

- 1 Close all DAQ 32 Plus software and click the Lock button (see below) on the Launcher toolbar. If the Launcher toolbar colors pink, the Project is locked.



- 2 To release the lock, close all DAQ 32 Plus software, and click the Lock icon. The Password Setting dialog box will appear.
- 3 Enter the password and click OK. The Project lock will be released.

2.4 Version and License Information

Launcher version and license information

To get version information for Launcher software click the Menu icon and select About... , or by double-click the Launcher icon on the taskbar and select About... .

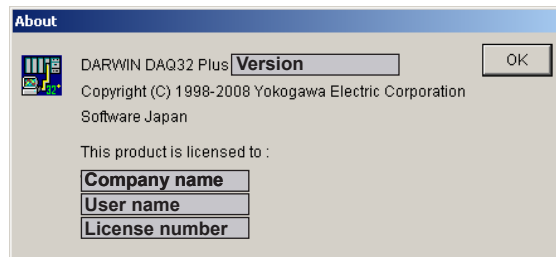

Version and license information for each DAQ 32 Plus software

To get version information for each DAQ 32 Plus software click the Help button, or select Help > About....

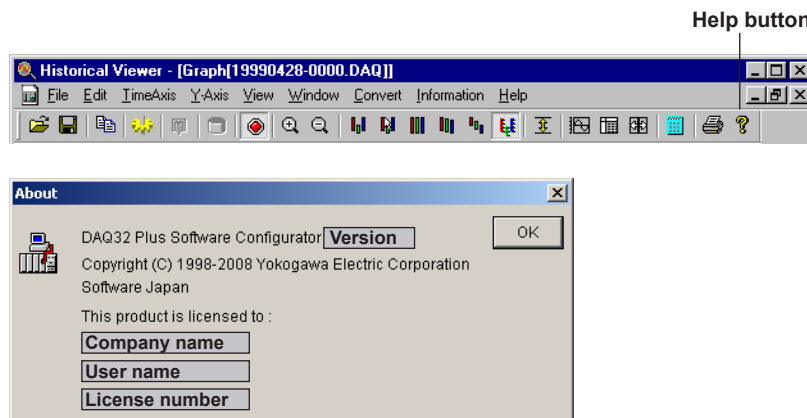

3.1 Using Software Configurator

Starting Software Configurator

Select the Project you want to open. Click the Software Configurator button on the Launcher toolbar, or right-click the Launcher icon on the taskbar and select Software Configurator.

Setting Screen

The Software Configurator setting screen should be similar to below illustration.

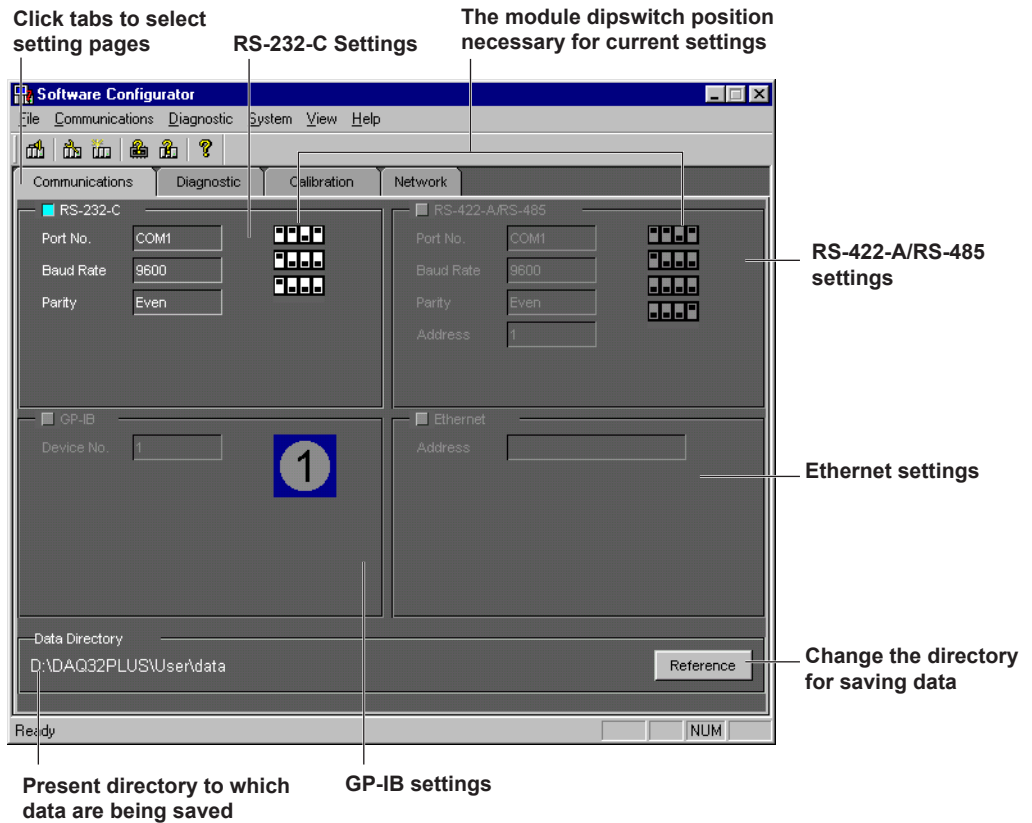

Setting Order

Before communicating with the DA100/DC100/DR, please take note of below difference in setting order.

For communication with GP-IB/RS-232-C/RS-422-A/RS-485

- 1 Make the Communication settings.
- 2 Reconstruct the System (Diagnostic > Reconstruct)
- 3 Make the Diagnostic settings.

For Ethernet communication

- 1 Set the DA100/DC100/DR IP address, Subnet Mask, and Default Gateway. (See Network Settings, next Section).
- 2 Make the Communication settings.
- 3 Reconstruct the System (Diagnostic > Reconstruct).
- 4 Make the Diagnostic settings.

For calibration see Chapter 8.

3.2 Network Settings

To use Ethernet for communication with DA100/DC100/DR, it is necessary to first make IP address, Subnet Mask, and Default Gateway settings for the DA100/DC100/DR.

Connection Method

Connect your PC to DA100/DC100/DR as described below. Connect only one DA100/DC100/DR to one PC.

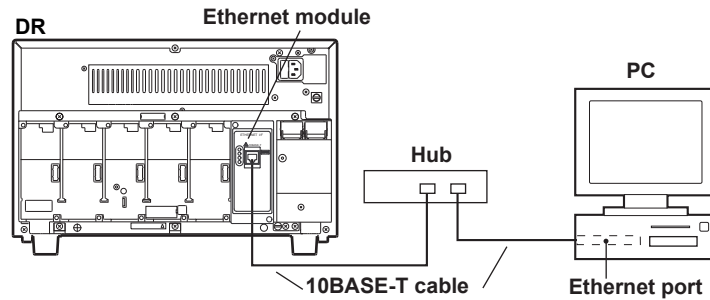

The Ethernet module mode must be the Set mode.

Network Settings

- 1 Switch on power of your PC and the DA100/DC100/DR, Startup DAQ 32 Plus and select Software Configurator with the Launcher toolbar.
- 2 Click the Network tab to display the setting screen for IP address, Subnet Mask, and Default Gateway (see below).

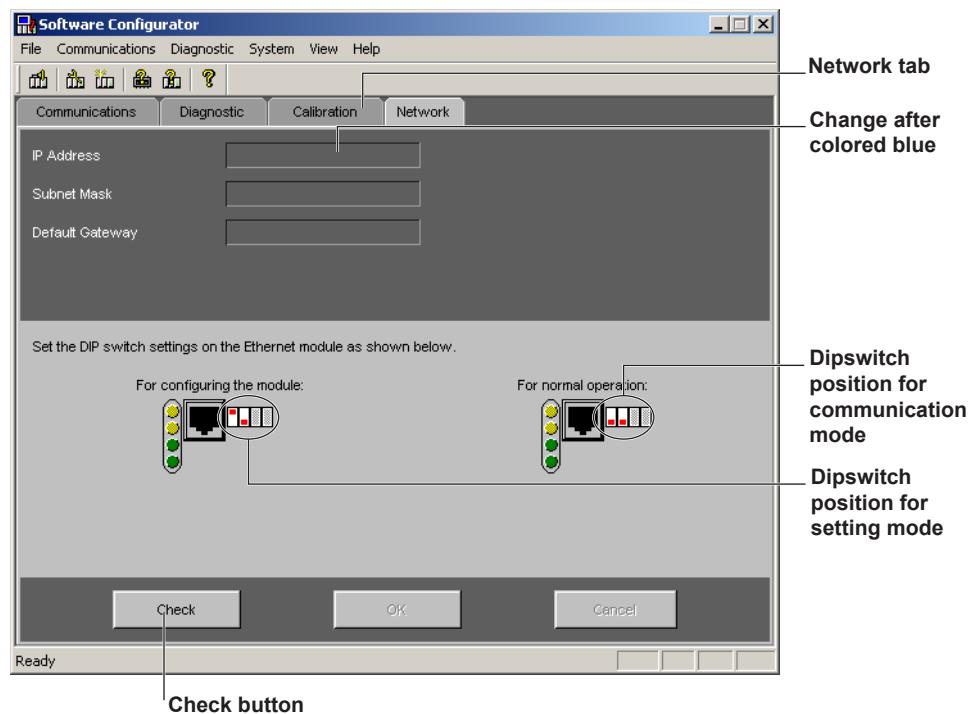

- 3 Click the Check button to get the currently used settings. If this is the first time you use the DA100/DC100/DR, initial values will get displayed.
- 4 If you click the digits in the IP address, Subnet Mask, or Default Gateway setting boxes, the clicked part will be invertedly displayed, allowing you to change the value.

- 5 Enter the appropriate setting values for IP address, Subnet Mask, and Default Gateway.

Note

Settings of IP address, Subnet Mask and Default Gateway can be made on the DC100, or DR.

- 6 After making the settings click OK, and again OK when a reconfirmation message appears, to activate the new network address (IP address, Subnet Mask, and Default Gateway). Click Cancel to finish settings.
- 7 Click OK when asked Close Network?, to finish the setting.

Note

When running under Windows XP (SP2) or Windows Vista, the Windows firewall sometimes prevents entry of the DAQ32Plus IP settings. If this occurs, you must disable the Windows firewall or add a Windows firewall exception. For instructions on how to add the DAQ32Plus Launcher as a Windows firewall exception, see the appendix in "*WX1000 DAQWORX Installation & Operation Guide*" (IM WX1000-01E).

3.3 Communication Settings

Use Software Configurator to set the communication method between PC and DA100/DC100/DR.

- 1 Startup DAQ 32 Plus and select Software Configurator with the Launcher toolbar.
- 2 Click the Communications tab to display the Communications setting screen. Select the desired communication method by clicking its setting frame, or click Communications and select the desired method.

RS-232-C, RS-422-A/RS-485, GB-IB

- 3 Click in the setting windows to display the listbox from which you can choose a value.

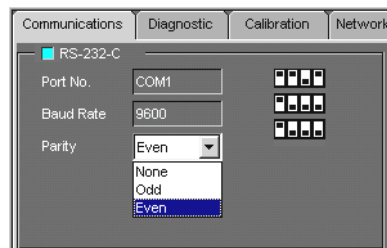

- 4 Set DA100/DC100/DR as follows.

- **RS-232-C, RS-422-A/RS-485**

If you use the setting windows for RS-232-C and RS-422-A/RS-485 the setting depending positions of the dip switches on the module, will also be displayed. After switching power OFF on the connected device, make sure to match the dip switch positions on the modules with those on the setting screen.

- **GP-IB**

After switching power on the connected device OFF, make sure for the GP-IB that the rotary switch on the module matches the address displayed on screen.

Ethernet

- 3 Set IP address of the connected device (DA100/DC100/DR).

Note

- Only change the dipswitch combination on the connected device, after power on the device is turned OFF.
- If settings don't match module settings a Communication error message will be displayed.

3.4 Selecting a Directory to Save Data

Use Software Configurator to select the directory you want to save Logger collected measurement data to. The default directory is the directory to which you saved DAQ 32 Plus software /DAQ32 Plus/User/data

- 1 Startup DAQ 32 Plus and select Software Configurator from the Launcher toolbar.
- 2 Click the Communications tab to display the Communications setting screen.
- 3 To open the Select Directory screen (below) click the Reference button in the Data Directory setting window (below), or click Communications > Data Directory from the menubar.

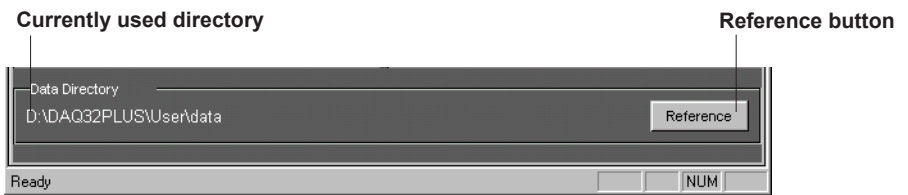

Select Directory screen



- 4 Choose a (earlier created) directory to save the collected measurement data to.

Creating a directory to save data to

- 4 Select a folder to store the directory you want to create.
- 5 Click Create directory... to open the Create directory dialogbox.
- 6 Enter the directory name in the text box and click OK. The created directory will appear.

Note

- When opening Launcher software, a User/data folder will automatically be created in the directory where you installed this software.
- Don't appoint a root-directory as the to save measurement data.
- Don't select a media like a floppy-disk drive as directory to save measurement data. Access time will increase, and it may not be possible to normally save data.

3.5 System Reconstruction/Scan/Initialization

Before starting measurement data collection make sure that units and modules of the DA100/DC100/DR are correctly connected. Check it again if a communication failure occurs.

Before System Reconstruction/Scan

Before starting system reconstructing and scanning please check the following:

Power supply:

- Verify that the power supply matches the requirements.
- Verify that the power supply is properly connected.

Status indicator (for DA100 only):

- Verify that the status indicator is lighting. (An internal error has occurred if the status indicator is flashing.)

Unit/Modules

- Verify that the environmental conditions match the requirements.
- Are all screws surely fastened?
- Are the right amount of modules in the right place?
- Verify that the number of connected modules and their locations are conform the specifications.

Communication Interface

- Verify that the communication interface cable is properly connected.
- Verify that the location of the communication module is correct (as it cannot be connected to a sub-unit).
- When using the GP-IB module, verify that the address setting is correct.
- When communicating by GP-IB interface, verify that the GP-IB driver has been installed.
- In case RS-232-C, RS-422-A/RS-485 modules are installed, are the communication settings correct?
- In case the Ethernet module is installed, are the network settings correct? Is TCP/IP protocol installed?

Note

If you use your DC100, or DR for the first time after purchasing it, make sure to first configure the instrument system, before communicating with this software.

System Reconstruction

If the connected DA100/DC100/DR is being used for the first time, or if any changes occurred to the system, connected units or installed modules, it is necessary to carry out the following steps to reconstruct the system.

- 1 Click the Diagnostic tab to display the Diagnostic setting screen.
- 2 To start reconstruction click the Reconstruction button (see below), or select Diagnostic > Reconstruct from the toolbar.



Reconstruction button

You will be asked to reconfirm the reconstruction request. Click OK to start reconstruction. Reconstruction will immediately be confirmed through an automatic scan. After this the new DA100/DC100/DR construction will be displayed on screen.

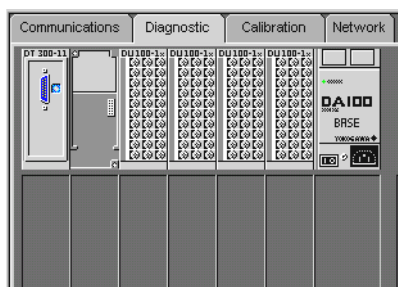

Note

If a module is incorrectly installed, a red-line signal will be displayed in the middle of the module. Reinstall the module and reconstruct again. If the signal reappears, the module may be broken. In that case, contact your nearest sales representative.

System Scan

The Scan function, checks device connections, and displays its condition.

- 1 Click the Diagnostic tab to display the Diagnostic setting screen.



Scan button

- 2 To start a scan click the Scan button (see above), or select Diagnostic > Scan from the menubar.

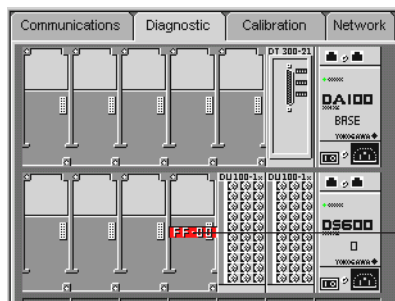

This red-line signal will be displayed, if a module is incorrectly installed. Reinstall the module and reconstruct again.

Note

- If the measurement range of the connected instrument is changed, restart the Launcher software, after connecting the instrument and starting communication.
- If communication isn't possible, please check the settings on the Communications window.
- Nothing will be displayed on the system construction screen, if after a scan a communication error occurs.
- On the system construction screen, the names of each module will appear on the bottom of the screen if selected by the mouse pointer.
- If a module is incorrectly installed, a red-line signal will be displayed in the middle of the module. Reinstall the module and reconstruct again. If the signal reappears, the module may be broken. In that case, contact your nearest sales representative.
- Stand-alone DR's (DR130/231/241) can not be reconstructed.

System Initialization

To initialize the settings of the connected device, do as follows:

- 1 Click the Diagnostic tab to display the Diagnostic setting screen.
- 2 To start initialization click the Initialization button (see below), or select Diagnostic > Initialize from the menubar.



Initialization button

Note

Inputs, Measurement range, etc, will be set to the default values of the currently installed input modules.

Display Errors

When Sub-Units don't Appear on the Display

- Verify that the power of the sub-unit is turned ON.
- Verify that the extension cables are properly connected.
- Verify that the unit number of the sub-unit conforms the setting of the rotary switch.
- Verify that after initializing the system no other sub-units have been connected.

When Modules don't Appear Correctly on Display

- Verify that the configuration of the modules is correct.
- Verify that after initializing the system no other modules have been wired.

When Any of the Following Errors Occur (red background)

The error(s) XX-YY will be displayed. The error YY means the following.

Error No.	Cause
C0	An input unit which does not match the system configuration has been connected.*1
C1	The module configuration has been altered after initializing the system
81	The number of connected modules exceeds the allowable number
82	Erroneous calibration has been carried out
83	Servicing is required*2

*1 Verify that the style number (for hardware) and release number (for software) match the following rules:

- module's style number \leq main unit's/sub-unit's style number.
- main unit's/sub-unit's style number \leq software's release number.

*2 Contact your nearest sales representative.

3.6 Confirming ROM Version and System Info

Confirming the ROM Version

To display the ROM versions of the connected devices click the Hardware Reference button (see below), or select System > Hardware Reference from the menubar.

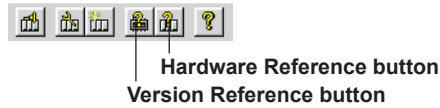

Example Hardware Reference Screen:

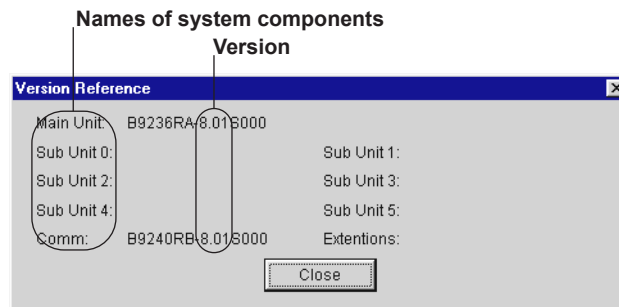

Note

The items displayed in the Version Reference, differ depending on the connected instrument.

Confirming the System Information

To display the System Information of the connected devices click the Version Reference button (see above), or select System > Version Reference from the menubar.

Example Version Reference Screen:

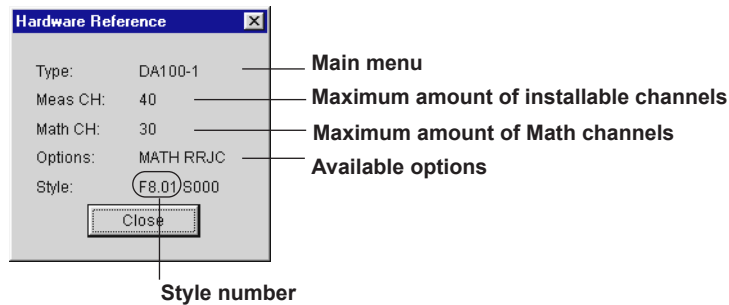

Note

The items displayed in the Version Reference, differ depending on the connected instrument.

4.1 Using DARWIN Hardware Configurator

DARWIN Hardware Configurator enables you to make settings to the DA100/DC100/DR. Settings differ for each device. The hardware setting data can be saved to a PC.

Starting DARWIN Hardware Configurator

Select the Project you want to open. Click the DARWIN Hardware Configurator button on the Launcher toolbar, or right-click the Launcher icon on the taskbar and select DARWIN Hardware Configurator.

Setting Screen

The DARWIN Hardware Configurator setting screen (for the DA100) should look like below illustration

File open button
Save button
Receive settings button
Print button
Tags
Menu bar
Toolbar

Channels	Mode	Scale	Wiring	Input Range	Range	Span		Scale	
						(L)	(R)	(L)	(R)
CH 001	VOLT	OFF			2V	-2.0000	2.0000		
CH 002	VOLT	OFF			2V	-2.0000	2.0000		
CH 003	VOLT	OFF			2V	-2.0000	2.0000		
CH 004	VOLT	OFF			2V	-2.0000	2.0000		
CH 005	VOLT	OFF			2V	-2.0000	2.0000		
CH 006	VOLT	OFF			2V	-2.0000	2.0000		
CH 007	VOLT	OFF			2V	-2.0000	2.0000		
CH 008	VOLT	OFF			2V	-2.0000	2.0000		
CH 009	VOLT	OFF			2V	-2.0000	2.0000		
CH 010	VOLT	OFF			2V	-2.0000	2.0000		
CH 011	VOLT	OFF			2V	-2.0000	2.0000		
CH 012	VOLT	OFF			2V	-2.0000	2.0000		
CH 013	VOLT	OFF			2V	-2.0000	2.0000		
CH 014	VOLT	OFF			2V	-2.0000	2.0000		

Setting items. Change when the setting screen is changed with a tab.
Setting area. Click to change. Enter the desired value, or select an item from the pull-down menu, if it appears
Vertical scroll
Horizontal scroll

Displayed tabs and setting items, differ depending on the kind of connected device.

Base Setting Data

Three kinds of data can serve as basis for further settings:

- Data earlier saved to the PC harddisk or to a floppydisk from the DA100, DC100, or DR.
- Setting conditions when Hardware Configurator closed last.
- Data settings of loaded from a DA100/DC100/DR connected to a PC.

Selecting Setting Screen

Settings screen contents differ depending on whether a DA100, DC100, or DR is the object. Select a setting screen by selecting Settings > SET (Regular) Settings, or Settings > SETUP (Basic) Settings, followed by the desired setting item; or by clicking a contents tab. Below examples of instrument setting screens.

DA100

Channels	Math	Event/Action	Timers	Constants	SETUP							
					Mode	Scale	Wiring	Input Range	Span		Scale	
									Range	(L)	(R)	(L)
CH 001	VOLT	OFF			2V	-2.0000	2.0000					

DC100

Channels	Math	Writing Operation	Event/Action	Timers	Messages	Constants	SETUP							
							Mode	Scale	Wiring	Input Range	Span		Scale	
											Range	(L)	(R)	(L)
CH 001	VOLT	OFF					-2.0000	2.0000						

DR

Channels	Math	Printing	Event/Action	Timers	Messages	Constants	SETUP							
							Mode	Scale	Wiring	Input Range	Span		Scale	
											Range	(L)	(R)	(L)
CH 001	VOLT	OFF					-2.0000	2.0000						

System Configurations

Changing any of the system configurations, will result in initialization of Hardware Configurator settings. Therefore, perform system configuration (Config. > System Configuration...) before making any other settings.

4.2 Loading Setting Data

Loading setting conditions when Hardware Configurator closed last.

- 1 Startup DAQ 32 Plus and select the desired Project using the Launcher's Project Settings. (See Section 2.3, "Switching and Protecting Projects").
- 2 The setting conditions at the moment the Project was closed for the last time will appear when Hardware Configurator is opened.

Loading settings from the hardware connected to your PC.

- 1 Startup DAQ 32 Plus and select Hardware Configurator with the Launcher toolbar.
- 2 Select Comm. > Receive from the menubar (see below).

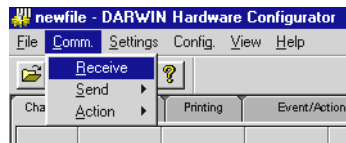

- 3 When asked Start Receiving? click OK to start loading down settings from the DA100/DC100/DR.

Note

- Data cannot be received when the Logger Monitor or Record function is active.
- When using ether communication, error detection may take a few minutes.
- When data were acquired with the DC100, a message may appear warning you that some changes have taken place. In that case, please check if all data have been acquired.

Loading data earlier saved to your PC's haddisk or to a hardware floppydisk.

It's possible to open the following data files.

- .ast: Data file received from a DA100.
 - .rst: Data file received from a DR.
 - .cst: Data file received from a DC100.
 - .set: Data file containing SET (Regular) Settings created with a DC100 or DR.
 - .pnl: Data file containing SETUP (Basic) Settings created with a DC100 or DR.
- When reading DC100 (.pnl) data, you may gat warned for data changes or incomplete loading. In that case, please check if all data have been acquired.

- 1 Startup DAQ 32 Plus and select Hardware Configurator with the Launcher toolbar.
- 2 Select File > Open... from the menubar, or click the File Open icon on the toolbar.



4.2 Loading Setting Data

The File Open dialog box will appear.

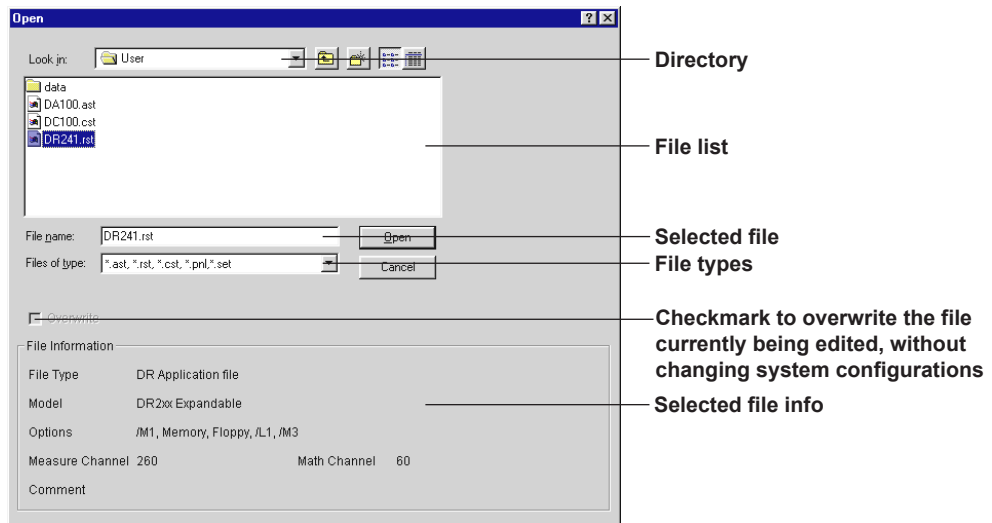

- 3 Select the desired file from the File list.
- 4 When you click Open the file will be opened, and all data of the open file, including its system configurations, will be cleared. Checkmark the Overwrite function if you want to overwrite the file currently being edited, without changing system configurations.
- 5 If you click open the data will be downloaded. If the setting data which are at that time being edited aren't saved yet, you will be asked whether to save them or not. A warning will be displayed, if all data can't be loaded.

The Overwrite function

If you open a file from the File list without using the Overwrite function, the file will be opened, clearing the data earlier edited open file, including its system configurations. If you use the Overwrite function when opening a file from the File list, the file will be opened, overwriting the data settings edited so far. System Configurations of the file edited so far will remain the same. If overwriting results in system inconsistencies, the entire file may be impossible to open.

Caution when loading a data file saved to a DC100/DR internal floppydisk.

If you open a file from a DC100/DR floppydisk, system info will not be included, and therefore it may be impossible to open the data using the overwrite function. To prevent this from happening, do the following:

- 1 Open the SETUP (Basic) Settings (which belong to the SET (Regular) setting file in (3)) without using the Overwrite function. A dialogbox for system configuration confirmation will appear.
- 2 Synchronize the system configurations and open the file.
- 3 Checkmark the Overwrite function and open the SET (Regular) settings.

4.3 Setting Input Range, Span, and Linear Scaling

Setting Input Range, Span, and Linear Scaling

- 1 To open the Channel Settings related setting screen, click the Channels tab, or select Settings > SET (Regular) Settings > Channel Settings from the menubar.

Channels	Math	Printing	Event/Action	Timers	Messages	Constants	SETUP		
	Mode	Scale	Wiring	Input Range	Range	Span		Scale	
						(L)	(R)	(L)	(R)
CH 001	VOLT	OFF			2V	-2.0000	2.0000		

Labels for the first table:

- Mode (input type)
- Scale ON/OFF
- Power monitor wiring
- Power monitor input range
- Measurement range
- Span left
- Span right
- Scale left
- Scale right

Channels	Math	Printing	Event/Action	Timers	Messages	Constants	SETUP		
		Ref.	Filter	Unit	Move Ave.	Alarm 1			
						Type	Value	Relay	Alarm Print
CH 001					OFF	OFF		ON2	OFF

Labels for the second table:

- Reference channel for Delta or RRJC mode
- Scale unit

- 2 Set the input type (Mode) in the pull-down menu which appears when you click the setting area below the Mode label. The content of the pull-down menu depends on the kind of modules that are active.
- 3 Linear Scaling will be possible, unless you selected above (2) SKIP (no measurement), DELTA (inter-channel calculations), or RJC (Remote RJC). For linear scaling Scale must be set ON. For the pulse module ON is fixed, and will not be displayed.
- 4 For power monitor modules make Wiring and Input Range settings. Wiring, and the Input Range is common for modules.

Note

Alarm settings will automatically be set OFF when wiring or the input range is changed.

- 5 Set the Range in the pull-down menu which appears when you click the setting area below the Range label. The content of the pull-down menu depends on the Mode selected at step (2).
- 6 Set the Span, left (L) and right (R).
- 7 Set the Reference Channel (Ref.) only if you selected the DELTA Mode (inter-channel calculations) at step (2) above.
- 8 For linear scaling Scale (L/R) and Unit settings are required (Scale must be set to ON -except for PULSE when ON is fixed). The Scale (L/R) setting range is -30000 to 30000. For pulse inputs, however, it is 0 to 30000. Units may contain a maximum of 6 alphanumeric (and: #, %, &, (), *, +, -, ., /).

4.3 Setting Input Range, Span, and Linear Scaling

Selecting the Range and Type of Input

The following types of input can be selected. The default setting is VOLT.

- SKIP
Measurement, data saving and display (except for page display) will not be carried out. Measurement, data saving and display will be carried out for the next channel whose input type is not set to SKIP.
- VOLT (DC voltage)
This input type can be selected from 20mV, 60mV, 200mV, 2V, 6V, 20V and 50V. Refer to chapter 14 for the measurement range of each setting. The default setting is 2V.
- TC (thermocouple)
This input type can be selected from R, S, B, K, E, J, T, N, W, L, U and KP (KPVsAu7Fe). Refer to chapter 14 for the measurement range of each setting. The default setting is R.
- RTD (resistance temperature detector)
This input type can be selected from PT1 (Pt100 1mA), PT2 (Pt100 2mA), JPT1 (JPt100 1mA), JPT2 (JPt100 2mA), PT50 (Pt50 2mA), NI1 (Ni100 1mA SAMA), NI2 (Ni100 1mA DIN), NI3 (Ni120 1mA), CU1 (Cu10 GE), CU2 (Cu10 L&N), CU3 (Cu10 WEED), CU4 (Cu10 BAILEY), PT1S (Pt100 1mA high resolution), PT2S (Pt100 2mA high resolution), JPT1S (JPt100 1mA high resolution), JPT2S (JPt100 2mA high resolution) and J263B (J263*B). Refer to chapter 14 for the measurement range of each setting. The default setting is PT1.
- DI (select LEVL (voltage level) or CONT (contact))
For LEVL, a voltage of less than approx. 2.4 V will be recognized as "0 (OFF)", whereas a voltage of approx. 2.4 V or more (max. allowable voltage is up to ± 60 VDC) will be recognized as "1 (ON)."
For CONT, an open, externally connected contact to which no voltage is applied, will be recognized as "0 (OFF)", whereas a closed contact will be recognized as "1 (ON)."
The default setting is LEVL.
- mA (DC current, mA input module)
This input can be set only for mA input channels. The measuring range is -20 mA to 20 mA.

Setting the Wiring Method

Select from the following methods:

- Single-phase two-wire (1Ph2W)
- Single-phase three-wire (1Ph3W; 3-wire input modules only)
- Three-phase three-wire 2 Voltage 2 Current (3Ph3W-2I; 3-wire input modules only).
- Three-phase three-wire 3 Voltage 3 Current (3Ph3W-3I; 3-wire input module only).
- Three-phase four-wire (3Ph4W; 3-wire input modules only).

Setting the Input Range

Select from the following ranges: 250V-0.5A / 250V-5A / 25V-0.5A / 25V-5A.

This setting is common to all channels. Any change to this setting also changes the settings of the rest of the channels. Impose a voltage or current signal to the input module within the limits you set here.

Note

If the connection method or input range is changed, alarm setting is turned off.

Strain

The measurement mode should be 2 k, 20 k, or 200 k. The measuring ranges are as shown below depending on the measurement modes and gauge methods.

Gauge method	2 k	20 k	200 k
1-gauge method	-2000 to 2000 $\mu\epsilon$	-20000 to 20000 $\mu\epsilon$	-200000 to 200000 $\mu\epsilon$
2-gauge method	-1000 to 1000 $\mu\epsilon$	-10000 to 10000 $\mu\epsilon$	-100000 to 100000 $\mu\epsilon$
4-gauge method	-500 to 500 $\mu\epsilon$	-5000 to 5000 $\mu\epsilon$	-50000 to 50000 $\mu\epsilon$

Note

If you have connected any new strain gauge or changed the measuring range initial balancing is necessary. (Initialization of settings or reconfiguration of the system also changes the measuring range back to its default).

- PULSE (not possible for DR130/231/241)
Select the RATE or GATE range.
- DELTA (difference between channels)
Computation can be done only in the same unit. Destination channels should lie within the first channel No. to the last channel No. range. The number of the reference channel (REF) should be lower than the number of the destination channels. The default setting for the reference channel is 01.
The type of input and the measuring range in the destination channel are the same as for the reference channel. After setting the DELTA (difference between channels), if you attempted to change the type of input and the measuring range, setting the difference between channels is released, thereby the type of input and the measuring range in the destination channel are returned to their original settings, and the span is returned to its initial value.
- RRJC (Remote RJC, available for instruments with the optional MATH function, only)
Reference channel (RJC): Within the setting range of reference channel No.
TC (thermocouple) must be selected as the type of input to the reference channel.
If the channel No. or type of input for the reference channel, or the type of thermocouple is changed, the alarm function will be turned OFF.
If the type of input for the reference channel or the type of thermocouple is changed, the RRJC settings will be cleared and the type of input and measuring range for the reference channel will be set to the one which was in effect before the change was made. The span will be set to the initial value of the measuring range.

Setting the Span

The measurement range is decided according to the type of input. The left and right span must lie within the measurement range. However, the span is 0 to 1 for the DI input type. By setting the span, the setting range for the upper/lower alarm limit of the rate-of-change is determined. The value on the left side of the SPAN menu shows the left span, and the value on the right side of the SPAN menu shows the right span.

For the remote RJC, the setting range for span is the same as that for the reference channel.

4.3 Setting Input Range, Span, and Linear Scaling

Selecting the Input Type for Linear Scaling

The input type can be selected from the following.

- VOLT (DC voltage)
- TC (thermocouple)
- RTD (resistance temperature detector)
- DI (contact)
- mA (DC current)
- AC (Power Monitor)
- STRAIN
- PULSE (For pulse, scaling setting is insufficient)

Setting Linear Scaling Values (SCL)

The left scaling and right scaling values are set following the left and right span values of the span menu. The value on the left side of the SCL menu shows the left scaling value, and the value on the right side of the SCL menu shows the right scaling value. The setting ranges from -30000 to 30000.

- The decimal point can be set in any position of the scale as shown below. Set it when the left scale is set.
“□.□□□□,” “□□.□□□□,” “□□□.□□□□,” “□□□□.□□□□,” or “□□□□□□.”
- The default settings are 0.00 for the left span and 100.00 for the right span.

Setting the power monitor channel number

This procedure sets the channel number for which you want to show and record the values of a parameter selected from the effective voltage, effective current, active power, reactive power, apparent power, frequency, power factor and phase angle which were calculated using the measured data. Therefore, it does not correlate with the terminals of an input module.

Setting power monitor parameters

A power monitor module measures the voltage or current through the respective channels. The values that are shown and saved are not those of the voltage and current being actually measured through each channel but the values of the parameters you set here.

A combination of parameters being measured is fixed for each group of channels 1-2, 3-4 and 5-6 within the same module. For example, setting channel 1 to P1 (active power 1) sets channel 2 to VA1 (apparent power 1). In addition, the configurable parameters being measured varies depending on the wiring method selected. See the lists on the next page for more information. The respective mnemonics in the lists should be interpreted as noted below:

V_i (i=1, 2, 3) : effective voltage	I_i (i=1, 2, 3) : effective current
$V_{13} : (V_1+V_3)/2$	$I_{13} : (I_1+I_3)/2$
$V_0 : (V_1+V_2+V_3)/3$	$I_0 : (I_1+I_2+I_3)/3$
P_i (i=1, 2, 3) : active power	Var_i (i=1, 2, 3) : reactive power
$P_{13} : P_1+P_3$	$Var_{13} : Var_1+Var_3$
$P_0 : P_1+P_2+P_3$	$Var_0 : Var_1+Var_2+Var_3$
VA_i (i=1, 2, 3) : apparent power	PF_i (i=1, 2, 3) : power factor
$VA_{13} : VA_1+VA_3$	$PF_{13} : P_{13}/(P_{13}^2+Var_{13}^2)^{1/2}=P_{13}/VA_{13}$
$VA_0 : VA_1+VA_2+VA_3$	$PF_0 : P_0/(P_0^2+Var_0^2)^{1/2}=P_0/VA_0$
PH_i (i=1, 2, 3) : phase	$FREQ$: frequency
$PH_{13} : \tan^{-1}(Var_{13}/P_{13})$	
$PH_0 : \tan^{-1}(Var_0/P_0)$	

Single-phase two-wire configuration

CH1	CH2	CH3	CH4	CH5	CH6
P1	VA1	V1	I1	PF1	PH1
				Var1	PF1
				FREQ	V1

Select from these combinations.

Single-phase three-wire/three-phase three-wire configurations
(dual-voltage, dual-current; modules for three-phase use only)

CH1	CH2	CH3	CH4	CH5	CH6
P1	VA1	V1	I1	PF1	PH1
P3	VA3	V3	I3	PF3	PH3
P13	VA13			PF13	PH13
				V1	I1
				V3	I3
				V13	I13
				FREQ	V1
				Var1	PF1
				Var3	PF3
				Var13	PF13

Select from these combinations.

Three-phase three-wire configuration
(triple-voltage, triple-current; modules for three-phase use only)

CH1	CH2	CH3	CH4	CH5	CH6
P1	VA1	V1	I1	PF1	PH1
P2	VA2	V2	I2	PF2	PH2
P3	VA3	V3	I3	PF3	PH3
P13	VA13			PF13	PH13
				V1	I1
				V2	I2
				V3	I3
				V13	I13
				FREQ	V1
				Var1	PF1
				Var2	PF2
				Var3	PF3
				Var13	PF13

Not valid if V2 for CH3, or I2 for Ch 4 are set.

Select from either of the two combination groups.

V0	I0	V1	I1	V1	I1
V1	I1	V2	I2	V2	I2
V2	I2	V3	I3	V3	I3
V3	I3				

Three-phase four-wire configuration
(modules for three-phase use only)

CH1	CH2	CH3	CH4	CH5	CH6
P0	VA0	V1	I1	PF0	PH0
P1	VA1	V2	I2	PF1	PH1
P2	VA2	V3	I3	PF2	PH2
P3	VA3	P0	VA0	PF3	PH3
		P1	VA1	V1	I1
		P2	VA2	V2	I2
		P3	VA3	V3	I3
				FREQ	V1
				Var0	PF0
				Var1	PF1
				Var2	PF2
				Var3	PF3
				P0	VA0
				P1	VA1
				P2	VA2
				P3	VA3

* Valid for style number 8 or higher

Select from either of the two combination groups.

V0	I0	V1	I1	V1	I1
V1	I1	V2	I2	V2	I2
V2	I2	V3	I3	V3	I3
V3	I3				

4.3 Setting Input Range, Span, and Linear Scaling

Setting the Span (SPAN)

Set the left and right spans within the limits of an input range. In the SPAN menu item, the left-hand value is the left span and the right-hand value the right span. Set the span within the measuring range. The measurable limits vary depending on the measuring range you select, as shown below.

	25V-0.5A	25V-5A	250V-0.5A	250V-5A
Effective voltage Vi (i=1,2,3,13,0)	0.00 to 25.00Vrms	0.00 to 25.00Vrms	0.0 to 250.0Vrms	0.0 to 250.0Vrms
Effective current Ii (i=1,2,3,13,0)	0.0000 to 0.5000Arms	0.000 to 5.000Arms	0.0000 to 0.5000Arms	0.000 to 5.000Arms
Active power P1,P2,P3	-12.50 to 12.50W	-125.0 to 125.0W	-125.0 to 125.0W	-1250 to 1250W
Active power P13	-25.00 to 25.00W	-250.0 to 250.0W	-250.0 to 250.0W	-2500 to 2500W
Active power P0	-37.50 to 37.50W	-375.0 to 375.0W	-375.0 to 375.0W	-3750 to 3750W
Apparent power VA1,VA2,VA3	0.00 to 12.50VA	0.0 to 125.0VA	0.0 to 125.0VA	0 to 1250VA
Apparent power VA13	0.00 to 25.00VA	0.0 to 250.0VA	0.0 to 250.0VA	0 to 2500VA
Apparent power VA0	0.00 to 37.50VA	0.0 to 375.0VA	0.0 to 375.0VA	0 to 3750VA
Reactive power Var1,Var2,Var3	0.00 to 12.50Var	0.0 to 125.0Var	0.0 to 125.0Var	0 to 1250Var
Reactive power Var13	0.00 to 25.00Var	0.0 to 250.0Var	0.0 to 250.0Var	0 to 2500Var
Reactive power Var0	0.00 to 37.50Var	0.0 to 375.0Var	0.0 to 375.0Var	0 to 3750Var
Power factor PFi(i=1,2,3,13,0)	-1.00 to 1.00	-1.00 to 1.00	-1.00 to 1.00	-1.00 to 1.00
Phase PHi(i=1,2,3,13,0)	-80.0 to 80.0deg	-80.0 to 80.0deg	-80.0 to 80.0deg	-80.0 to 80.0deg
Frequency FREQ	45.00 to 65.00Hz	45.00 to 65.00Hz	45.00 to 65.00Hz	45.00 to 65.00Hz

Precautions in Power Module Measurement

Input the voltage or current being measured at a level between 10% and 100% of the measuring range. The instrument bases its calculations of all other parameters on the frequency of V1. Extra care must therefore be taken when setting the input level of V1. If the input level fails to fall within the given limits, there is no guarantee that the measurement of any other parameters will be reliable.

4.4 Alarm Settings

In this Section you will find the setting methods for different kinds of alarm, the alarm level, and the alarm output relay.

Alarm Setting Procedures

- 1 To open the Channel Settings related setting screen, click the Channels tab, or select Settings > SET (Regular) Settings > Channel Settings from the menubar. For the Math channel related setting screen click the Math tab, or select Settings > SET (Regular) Settings > Math Functions from the menubar.

Channels		Math	Event/Action			Timers	SETUP		
		Are.	Alarm 1		Alarm relay		Alarm 2		Alarm
		Type	Value	Relay	Type	Value	Relay	Type	Val
CH 011		L	-0.5000	S01	OFF			OFF	

- 2 Set the Type (alarm type) in the pull-down menu which appears when you click the setting area below the Type label. Select OFF if not using any alarm.
- 3 Set the alarm Value. The value range depends on the selected alarm type.
- 4 Set the alarm output relay (Relay). To set the relay terminal of an alarm output relay module or the relay terminal of a DI/DO module, select a relay number. To set an internal switch choose from S(=switch)01 to S60.
- 5 For a DR you can choose to print a mark, and an additional message, at the time an alarm occurs.

Channels		Math	Printing	Event/Action			Timers	Messages			Constants	SETUP
		Alarm 1		Alarm print ON/OFF			Message setting			Alarm 2		
		Type	Value	Relay	Alarm Print	Message	Type	Value	Relay	Alarm Pr		
CH 001		OFF			ON2	OFF	OFF			ON2		
CH 002		OFF			ON1	OFF	OFF			ON1		

To get a mark printed, click a channel below the Alarm Print label and use the pull-down menu to select OFF, ON1, or ON2

- 6 To get a message printed, click a channel below the Message label and use the pull-down menu to select the desired message number, or to select OFF for no message.

Selecting the type of alarm

Select an alarm type for each alarm number from among the following:

- **OFF** (default set) : No alarm is set.
- **H** : Upper-limit alarm. An alarm occurs when the measured value exceeds the upper-limit alarm setpoint.
- **L** : Lower-limit alarm. An alarm occurs when the measured value exceeds the lower-limit alarm setpoint.
- **RH** : Rate-of-change upper-limit alarm. An alarm occurs when the measured value changes in the increasing direction within a certain time (rate-of-change alarm interval) and exceeds the upper-limit alarm setpoint.

4.4 Alarm Settings

- **RL** : Rate-of-change lower-limit alarm. An alarm occurs when the measured value changes in the decreasing direction within a certain time (rate-of-change alarm interval) and exceeds the lower-limit alarm setpoint.
- **dH** : An alarm occurs when the difference between two channels exceeds the upper-limit alarm setpoint. This only applies to a channel for which interchannel differential computation is selected, and can be set as a type of alarm.
- **dL** : An alarm occurs when the difference between two channels exceeds the lower-limit alarm setpoint. This only applies to a channel for which interchannel differential computation is selected, and can be set as a type of alarm.

See also Section 4.20, “Setting Alarm Interval, Hysteresis, and Alarm Display Hold.” Only H (upper-limit alarm) and L (lower-limit alarm) are available for computation channels.

Note

- Alarms can't be set if the input type is SKIP, or if the Math channel mode is OFF.
 - If you make below changes, channel alarms will automatically be switched OFF:
 - Input type.
 - Measurement range.
 - Reference channels of inter-channel computations.
 - RRJC reference channels, reference channel inputs, or thermocouples.
 - Setting Math channels ON, OFF, Math equations
-

Setting alarm values

Set one alarm value for each alarm number within the following range, depending on the type of input. The default value is 0 (zero).

H and L

- VOLT, TC, RTD, DI, DELTA, AC, STRAIN, mA, and PULSE: Within the measuring range in the related channel. DI can be set to either 0 or 1.
- SCALE: Within a linear scaling value.
- Math channel: Within the range specified by the Math function.

RH and RL

- VOLT, TC, RTD, DI, and DELTA, AC, STRAIN, mA, and PULSE: Within 1 to [maximum measuring range minus minimum measuring range] in the related channel. For example, set 30000 (without using a decimal point) if the maximum value exceeds 30000. DI can be set to only 1.
- SCALE: Set 1 to 30000 without using a decimal point.

dH and dL

- When the reference channel uses VOLT: Within the measuring range.
- When the reference channel uses other than VOLT: [maximum measuring range minus minimum measuring range] to - [maximum measuring range minus minimum measuring range]

Note

- When setting alarm values in continuous channels, use the decimal point as follows:
The decimal point of an alarm value when the continuous channels have different measuring ranges should be in the position determined by the individual measuring range. If the decimal point is outside the measuring range, an error occurs. For example, if channels with measuring ranges 20 mV and 2 V, and a type T thermocouple channel, are all set to an alarm value of 10000, then the alarm values in the respective channels are as follows:
10.000 mV in the 20 mV measuring range channel
1.0000 V in 2 V measuring range channel
1000.0°C in the type T thermocouple channel
- A type T thermocouple has a measuring range from –200.0 to 400.0°C, so an error results.
- If you make below changes, channel alarm values will also change automatically:
 - Recording span.
 - Linear scaling settings.
 - Power monitor channel wiring and input range.

Setting Relays (Internal Switches)

Set which alarm output relay or internal switch should be triggered when an alarm occurs:

- Select the desired alarm output relay or internal switch from among the following. The default setting is OFF.
 - OFF : Alarm output relays and internal switches remain OFF.
 - S01 to S60 : 60 internal switches are provided.
 - UMN
U : Unit number for an alarm module or a DI/DO module. M: Slot number for an alarm module or a DI/DO module. N: Number 0 to 9. For details, see page 3-8.
- Multiple alarm setpoints can be set for one alarm output relay or internal switch.
- The operation mode in the alarm output relay or internal switch can be set when an alarm occurs. For details, see Section 4.21, “Setting Relay and Internal Switch Actions.”
- When the alarm module or DI/DO module is not recognized as system module, the relay is set to OFF.

Selecting the Alarm Printout (DR only)

This setting can be selected from the following. The default setting is ON2.

OFF: Alarm printout will not be carried out;

ON1: Alarms will only be printed out on occurrence.

The alarm occurrence mark, channel No. or tag, type of alarm, alarm heading or time of occurrence will be printed with trend recordings.

ON2: Alarms will both be printed out on occurrence and release.

The alarm occurrence/release mark, channel No. or tag, type of alarm, alarm heading or time of occurrence/release will be printed with trend recordings.

Selecting a Message Printout (DR only)

This setting specifies whether to print a message on alarm occurrence, and if so, which message will be printed. The default setting is OFF.

OFF: No message will be printed.

See also Section 4.17, “Setting Messages (DR Only).”

4.5 Setting Moving Average and Filter

Moving Average Settings

- 1 To open the Channel Settings related setting screen, click the Channels tab, or select Settings > SET (Regular) Settings > Channel Settings from the menubar.

Channels	Math	Printing	Event/Action	Timers	Messages	Constants	SETUP					
	Zone		Partially Expanded			Interpolation	Trend Print	Digital Print	Manual Print	Scale Print	List Print	
	(L)	(R)	Use	Position	Boundary							
CH 001	0	260	OFF			OFF	ON	ON	ON	ON2	ON	
CH 002	0	260	OFF			OFF	ON	ON	ON	ON2	ON	

- 2 Set the moving average in the pull-down menu which appears when you click the setting area below the Mode label.

Moving Average (MOVE AVE)

Moving average can be set for each channel individually. The number of samples used for the moving average can be set from 2 to 64. The default value is 0, which means that no moving average is carried out. The result of the moving average is recorded and displayed.

Filter Settings

- 1 To open the Channel Settings related setting screen, click the Channels tab, or select Settings > SET (Regular) Settings > Channel Settings from the menubar.
- 2 Set the Filter ON or OFF in the pull-down menu which appears when you click the setting area below the Filter label. Filter settings are only possible for pulse input. Setting the Filter ON can eliminate pulse chattering of up to 5 ms.

4.6 Recording-related Settings (DR Only)

In this Section the following recording-related setting for DR:

- Recording zones
- Partially expanded recording
- Interpolation
- Trend recording
- Digital printout ON/OFF
- Manual printout ON/OFF
- Scale printout ON/OFF
- List printout ON/OFF

Setting Procedure

- 1 To open the Channel Settings related setting screen, click the Channels tab, or select Settings > SET (Regular) Settings > Channel Settings from the menubar. For the Math channel related setting screen click the Math tab, or select Settings > SET (Regular) Settings > Math Functions from the menubar.

Channels	Math	Printing	Event/Action	Timers	Messages	Constants	SETUP					
	Zone		Partially Expanded			Interpolation	Trend Print	Digital Print	Manual Print	Scale Print	List Print	
	(L)	(R)	Use	Position	Boundary							
CH 001	0	250	OFF			OFF	ON	ON	ON	ON2	ON	
CH 002	0	250	OFF			OFF	ON	ON	ON	ON2	ON	

- 2 To specify the recording zone, set the left and right position. The distance between the two sides should be more than 55 mm.
- 3 Set partially expanded recording ON or OFF, and set the Position and Boundary. Position and Boundary can't be set if partially expanded recording is OFF.
- 4 Set Interpolation ON or OFF. If set to ON, interpolation will be carried out according to the priority order of recording colors.
- 6 Set Trend Print ON or OFF. Only channels set ON will get a trend printout.
- 7 Set Manual Print ON or OFF. Only channels set ON will get a manual printout.
- 8 Set Scale Print to ON1/ON2/ON3 to print Scale values during trend recording, or OFF.
- 9 Set List Print ON or OFF. The contents of channels set to ON will be included in the List printout.

Setting Recording Zones (ZONE)

The set left and right position of the zone correspond to the left and right span set at the SPAN menu (recording span). Zones can be set in 1mm steps and cannot exceed the recording range (i.e. 250mm). The left position setting ranges from 0 to 245mm. Right position setting ranges from 5 to 250mm. The minimum width of a zone is 5mm. No decimal points. Default settings: 0mm for the left position, 250mm for the right position. If the instrument is equipped with the optional Math function, or if it has a pulse module or a FDD (DR232/DR242) attached, this setting can also be made for computation channels A01 to A60.

Partially Expanded Recording (PARTIAL)

This setting specifies whether to carry out partially expanded recording, and if so, which percentage of the recording span will be compressed and the corresponding boundary value.

If the instrument is equipped with the optional computation function or floppydisk drive, this setting can also be made for computation channels A01 to A60.

Selecting Partial Recording ON/OFF

ON: Partial recording will be carried out;

OFF: Partial recording will not be carried out.

Specifying the Compressed Part and Boundary Value

- RATE : This setting specifies which percentage (1 to 99%) of the full recording span will be compressed. The default value is 50%.
- Boundary value: This setting specifies the boundary value which corresponds to the previous set compressed part. The setting lies within the recording span, but when linear scaling is being used, the setting lies within the left/right scale range. The default value is 0.

Note

If boundary values are to be set for succeeding channels, the decimal point is handled as below.

If succeeding channels are set, the decimal point position of boundary values when the measurement range for each channel setting is different, is that determined for each corresponding range. As a result, it exceeds the measurable range, an error occurs.

For example, if channels whose measurement ranges are 20 mV, 2 V, and type T thermocouple are set and the boundary value is set to 10000, the following applies:

The boundary value of the channel whose measurement range is 20 mV: 10.000 mV;

The boundary value of the channel whose measurement range is 2 V: 1.0000 V; and

The boundary value of the channel whose measurement range is type T thermocouple: 1000.0 °C

As the range of type T thermocouple is -200.0 to 400.0 °C, an error occurs for this channel.

Notes on Partially Expanded Recording

- Partial recording cannot be carried out if the input type of the computation channels is SKIP or DI or if the computation channels are OFF.
- Partially expanded settings will be automatically canceled when either of the following changes occur.
 - the input type has been changed;
 - the measurement range has been changed;
 - the recording span has been changed;
 - linear scaling settings have been changed;
 - the reference channel for difference between channels has been changed.

Interpolation (INTERPOL)

This setting can be set for each channel individually. If the instrument is equipped with the optional computation function or floppydisk drive, this setting can also be made for computation channels A01 to A60. The default setting is OFF.

OFF: no interpolation will be carried out.

ON: interpolation will be carried out according to the priority of recording colors. The priority of recording colors is black > purple > reddish purple > navy blue > red > blue > brown > green > orange > yellowish green.

Digital Printout Setting (DIGITAL PR)

This setting can be selected for each channel from the following. This setting applies to the digital print of the analog mode and logging mode.

The recording interval can be selected from the following.

If the instrument is equipped with the optional computation function or floppydisk drive, this setting can also be made for computation channels A01 to A60.

When LOG INTERVAL is set to SINGLE: The recording interval is decided automatically, depending on the chart speed, and the columns of channels to be printed.

When LOG INTERVAL is set to MULTIPLE: The recording interval can be selected from six timer settings. The default value is 1.

Trend Recording

Recording can be set ON/OFF per channel. The default setting is ON.

Manual Printout Setting (MANUAL PR)

This setting can be selected from the following. The default setting is ON.

If the instrument is equipped with the optional computation function or floppydisk drive, this setting can also be made for computation channels A01 to A60.

OFF: Manual printout will not be carried out for this channel;

ON: Manual printout will be carried out for this channel.

Scale Printout (SCALE PR)

Assigned to each channel individually. The scaled values will be printed out with trend recordings. No printout if a zone of 49mm or less is set. The scaled values of the following channels will be printed. If the instrument is equipped with the optional computation function or floppydisk drive, this setting can also be made for computation channels A01 to A60.

When Partial Expanded Recording is OFF

OFF : Scaled values will not be printed.

ON1 : • when the recording zone is 150mm or more: scaled values at each 20%-interval of the recording span will be printed at positions at 20%-intervals of the zone.

• when the recording zone is 50mm to 149mm: scaled values at 0% and 100% of the recording span will be printed at 0% and 100% positions of the zone.

ON2 : Scaled values at 0% and 100% of the recording span will be printed at 0% and 100% positions of the zone.

ON3 : • when the recording zone is 100mm or more: scaled values at 0%, 50% and 100% of the recording span will be printed at 0%, 50% and 100% positions of the zone.

• when the recording zone is 50mm to 99mm: scaled values at 0% and 100% of the recording span will be printed at 0% and 100% positions of the zone.

When Partial Expanded Recording is ON

OFF : Scaled values will not be printed.

ON1/ON2/ON3 : When the recording zone is 100mm or more: scaled values at 0%, 100% of the recording span and at the boundary value will be printed at 0%, 100% and boundary value positions of the zone. When the recording zone is 50mm to 99mm: scaled values at 0% and 100% of the recording span will be printed at 0% and 100% positions of the zone.

List Printout (LIST PR)

This setting can be assigned to each channel individually. Starting a list printout can be done at the PRINT menu. For instruments with the optional Math function or floppydisk drive, this setting can also be made for computation channels A01 to A60.

OFF: List printout will not be printed.

ON: Setting information per channel will be printed.

4.7 Selecting Channels to Save (for DC100, and DR with FDD Option Only)

To save measurement data of the DC100, or a DR with FDD Option, to a floppydisk, data will first be saved to an internal RAM disk. To select the measurement or Math channels which data you want to write to the internal memory, follow below procedures:

- 1 To open the Channel Settings related setting screen, click the Channels tab, or select Settings > SET (Regular) Settings > Channel Settings from the menubar. For the Math channel related setting screen click the Math tab, or select Settings > SET (Regular) Settings > Math Functions from the menubar.

Select here the channels to be saved

Channels	Math	Writing Operation	Event/Action	Timers	Messages	Constants	SETUP
	Alarm 3		Alarm 4		Tag		Memory
	Value	Relay	Type	Value	Relay		
CH 001			OFF				ON

- 2 Select ON to save data to internal memory/floppydisk, or OFF, in the pull-down menu which appears when you click the setting area below the Memory label (on the far right side of the Channels setting screen).

4.8 Tag Settings (DC100 or DR Only)

- 1 To open the Channel Settings related setting screen, click the Channels tab, or select Settings > SET (Regular) Settings > Channel Settings from the menubar. For the Math channel related setting screen click the Math tab, or select Settings > SET (Regular) Settings > Math Functions from the menubar.

Tag setting

Channels	Math	Writing Operation	Event/Action	Timers	Messages	Constants	SETUP
	Alarm 3		Alarm 4		Tag		Memory
	Value	Relay	Type	Value	Relay		
CH 001			OFF				ON

- 2 Set a tag in the setting area below the Tag label. Maximum amount of alphanumerics for DC100: 8; for DR: 16. Additionally allowed symbols #, %, &, (), *, +, -, ., and /.

4.9 Making Settings Per Channel

The settings explained in Section 4.2 to 4.8 can also be carried out per channel, by following below procedures:

- 1 To open the channel settings related setting screen, click the Channels tab, or select Settings > SET (Regular) Settings > Channel Settings from the menubar.
- 2 To open a single channel-specific setting screen, double-click the desired channel number, displayed on the left side of the Channels setting screen.

The screenshot shows the 'CH 001' dialog box with the 'Regular Setting' tab selected. The 'Input' section includes a 'Type of Input' dropdown set to 'VOLT', a 'Reference' dropdown, a 'Range' dropdown set to '2V', 'Span(L)' and 'Span(R)' text boxes containing '-2.0000' and '2.0000' respectively, 'Linear Scaling' and 'Scale(L)'/'Scale(R)' checkboxes and text boxes, an 'Engineering Unit' text box, and a 'Moving' dropdown set to 'OFF'. The 'Alarm' section contains a table with columns 'Type', 'Value', and 'Relay' for four alarms, all set to 'OFF'. A 'Range of Value' section on the right shows 'H/L' values '-2.0000/' and '2.0000', and 'RH/RL' values '0.0001/' and '3.0000'. A 'Tag' text box and a checked 'Memory Save' checkbox are at the bottom. 'OK' and 'Cancel' buttons are at the bottom right.

- 3 If a DR is connected, you can make print settings in the setting screen that appears when clicking the About Printing tab.

The screenshot shows the 'CH 001' dialog box with the 'About Printing' tab selected. The 'About Printing' section includes 'Zone(L)' and 'Zone(R)' text boxes with values '0' and '250', 'Partially Expanded', 'Interpolation', 'Trend Printout', 'Digital Printout', 'Manual Printout', 'Scale Printout', and 'List Printout' checkboxes, a 'Position' dropdown, a 'Boundary' text box, a 'Recording Interval' dropdown, and a 'Scale Printout Type' section with radio buttons for 'ON1', 'ON2', and 'ON3'. 'OK' and 'Cancel' buttons are at the bottom right.

- 4 Click the Range Information tab to select the type of input and to make range related settings.

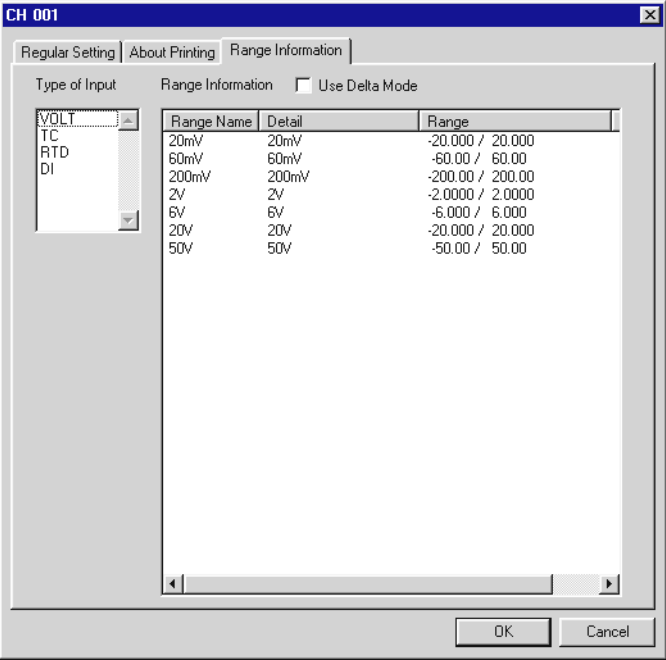

- 5 For power monitor channels, click the Power Module Information tab.

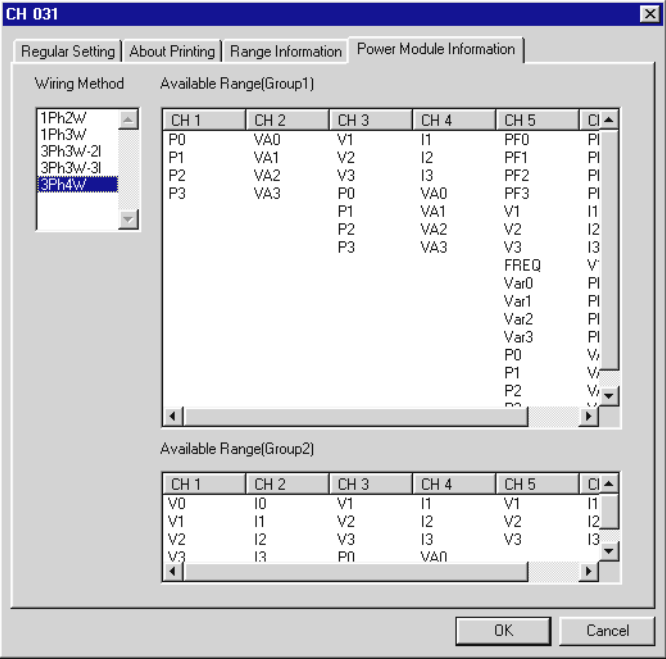

4.10 Transmission Output Channel Assignment

Specify which channel the measurement results, calculation results, or communication input values will be output from each terminal of the transmission output module.

1. Use one of the following methods to display the setting screen:
 - Click the [Channels] or [Math] tab and then click the [Retransmission] button in the measurement channel or calculation channel settings page. The transmission output channel assignment dialog box is displayed.
 - Choose [Settings]/[SET(Regular) Settings]/[Retransmission Output Channels] from the menubar. The transmission output channel dialog box is displayed.

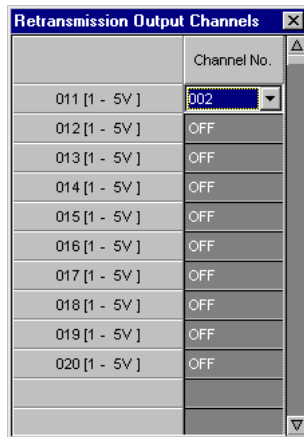

2. Set the transmission output channel for each input, calculation, or communication channel.

4.11 Setting Math Channel Equations

- 1 For the Math channel related setting screen click the Math tab, or select Settings > SET (Regular) Settings > Math Functions from the menubar.

Math channel ON/OFF		Equations	Left and right span		Unit
Channels	Math	Equation	Span		Unit
			(L)	(R)	
CH A01	ON	001+002	-200.0	200.0	
CH A02	ON	ABS(003)	-200.0	200.0	

- 2 Set Math ON to activate the Math channel.
- 3 Set a Math Channel Equation. To use the equation operators, first double-click the desired Math channel number, displayed on the left side of the Math setting screen. Then, click the square button on the right side of the equation setting box. In the Operators Selection dialog box choose the desired equation operator, which will appear in the equation setting box when clicked.

- 4 Set the display/recording span in the -9999999~9999999 range.

4.11 Setting Math Channel Equations

- 5 Set the Unit you want to use for calculation using maximum 6 alphanumericals or the symbols #, %, &, (), *, +, -, ., and /.
- 6 Alarm settings and printing-related DR settings, are equal to those made for measurement channels.

Computation equation

In addition to operators in the Operators Selection dialog box the following symbols can be used in equations:

- (/): Used for () setting.
- K: Used if equations contain constants K01 to K60.
- M: Used to specify the measurement channel No. for which the data saved on the RAM disk is to be re-generated. Applicable for the DR232-1/DR242-1 equipped with a floppydisk drive.
- A: Used to specify the computation channel No. for which the data saved on the RAM disk is to be re-generated. Applicable for the DR232-1/DR242-1 equipped with a floppydisk drive.
- C: Used to specify communication input data (digital data).
- G: Used to specify the group No. for which CLOG (computation of data of a group measured on the same time) is to be used.

Restrictions in equations

- The specified computation equation for a computation channel No. can contain only computation channel Nos. as variable which are equal to or smaller than set computation channel No.
(Example) $A02=001+A01$
In this example, any computation channel No. which is equal to or greater than A03 cannot be used.
- Either TLOG or CLOG can be used in an equation.

Note

- Each equation must consist of up to 40 characters.
 - The total number of channels and constants to be used for each equation is 16 or smaller.
-

4.12 Copying Channel Settings

Copy measurement and Math settings to other channels as follows.

- 1 To open the Channel Settings related setting screen, click the Channels tab, or select Settings > SET (Regular) Settings > Channel Settings from the menubar. For the Math channel related setting screen click the Math tab, or select Settings > SET (Regular) Settings > Math Functions from the menubar.
- 2 Click the channel number which settings you want to copy to other channels The display color changes.

Click here the copy base or copy destination

Channels	Math	Printing	Event/Action	Timers	Messages	Constants	SETUP	
	Mode	Scale	Wiring	Input Range	Range	Span		Sd
						(L)	(R)	(L)
CH 001	VOLT	ON			6V	2.000	6.000	0
CH 002	VOLT	ON			6V	-4.500	4.500	0
CH 003	VOLT	OFF			2V	-2.0000	2.0000	

- 3 Click the copy button in lower left corner of the setting screen.

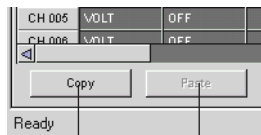

Copy button Paste button

Below dialog box will appear to select the items you wish to copy to other channels.

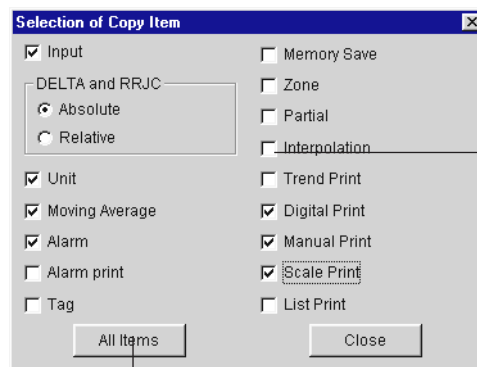

Items to copy

Click to select all items

- 4 Select the desired items to copy, and then close the dialog box.
- 5 Click the first channel you want to copy the settings to, and drag the mouse pointer down to the last channel the settings should be copied to. The display color of the selected channels changes.
- 6 Click the Paste button, to copy the selected settings to the selected channels.

Absolute and relative position settings for DELTA, RRJC

When copying DELTA and RRJC channels, it is necessary to determine the relation to reference channels.

- **Absolute position**

The reference channel of the copy destination doesn't change.

For example, if the reference channel of Ch 005 is Ch 002, and you would copy Ch 005 settings to Ch 007, the reference channel of Ch 007 will remain Ch002.

However, if you are copying between units, the reference channel of the copy destination will change.

For example, if the reference channel of Ch 005 is Ch 002, and Ch 002 settings are TC, Type R, and you would copy Ch 005 settings to Ch 107, the reference channel of Ch 107 will become Ch 102. Copying is, in this case, only possible if Ch 102, like Ch 002, is set to TC, Type R, and in addition, the scale must be set OFF.

- **Relative position**

The relative positions of channels and relative channels set in DELTA or RRJC, will be maintained when copied. Therefore the reference channel of copy destination and copy base will differ.

For example, if the reference channel of Ch 005 is Ch 002, and Ch 002 settings are TC, Type R, and you would copy Ch 005 settings to Ch 009, the reference channel of Ch 009 will become Ch 002. Copying is, in this case, only possible if Ch 009, like Ch 002, is set to TC, Type R. It is advisable to let the copying include the reference channel.

4.13 Setting Constants

Up to 60 constants (K01 to K60) can be set. (Thirty constants (K01 to K30) for the stand-alone type.)

The number of significant digits is 5 excluding the decimal point. If an exponent is used, the mantissa and exponent must consist of 5 digits and 2 digits, respectively.

- Configurable ranges:
 - 1.0000E+35 to –1.0000E-35
 - 0
 - 1.0000E-35 to 1.0000E+35

- 1 Click the Constant tab, or select Settings > SET (Regular) Settings > Constants from the menubar

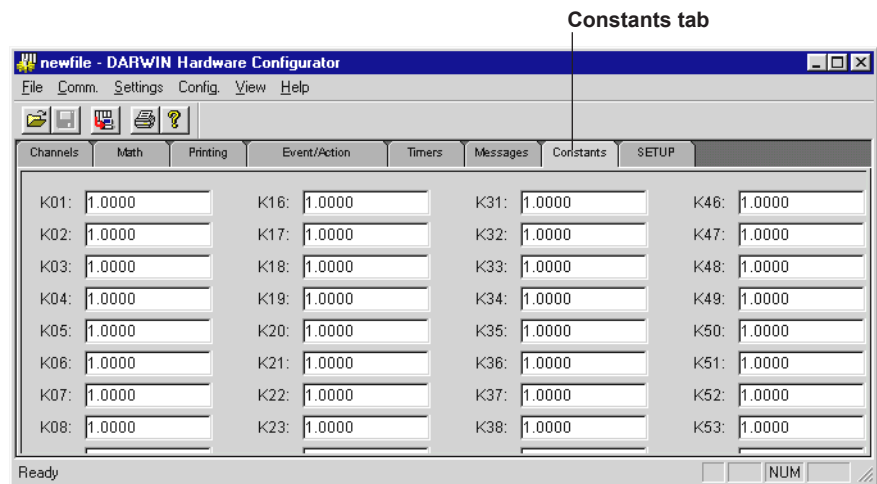

- 2 Set the Constants in the above Constants setting screen.

4.14 Event/Action, Match Time, and Group Settings

Event/Action and Match Time settings are possible for the DA100, if the (/M1) Math option is being used, or if a pulse module is attached.

For DA100 and DC100, Group settings are possible if the Math option is being used.

- 1 Click the Event/Action tab, or select Settings > SET (Regular) Settings > Event/Action, > Match Times, or > Groups, from the menubar. The Event/Action, Match Time, Groups setting screen will open.

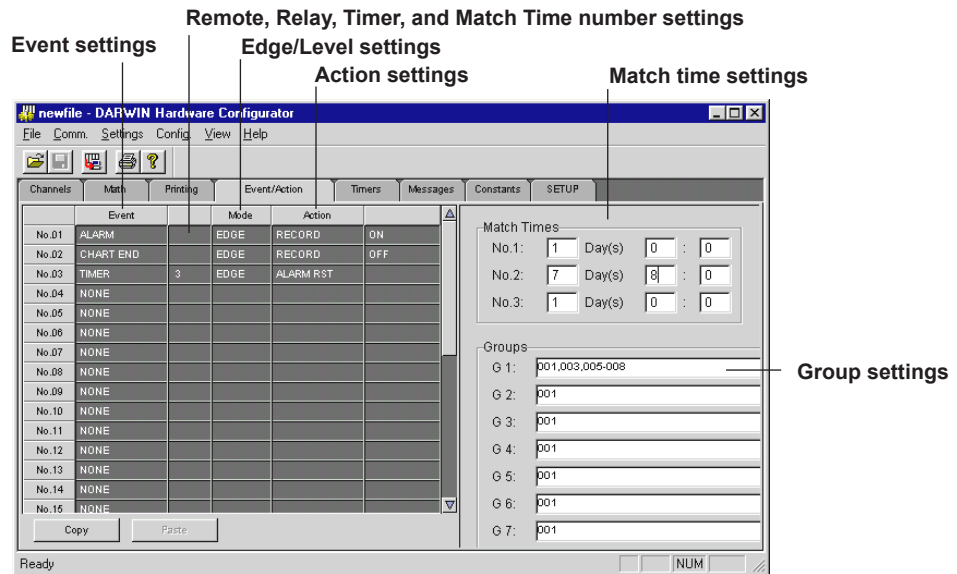

- 2 Select an Event using the pull-down menu which appears when you click the setting area below the Event label.
- 3 If you use REMOTE, RELAY, TIMER, MATCH TIME, or (for the DR) MFUNC as an Event setting, enter the appropriate number.
- 4 Select the Edge or Level mode in the setting space under the Mode label.
- 5 Select an action in the setting space under the Action label. The kind of actions you can select depends on the events selected earlier.
- 6 Depending on the action selected above (5), it may be necessary to make additional settings on the right of the setting space under the Action label. Use the pull-down menu to make a selection..
- 7 Set the Match Times, days and time, in the Match Times dialog box.
- 8 Make the Groups setting. Divide the channels you choose for the Group setting by commas. Between a continuing series of channel numbers place a hyphen.
For example : 001,005,008
001-005 (channel 001 to 005)

Selecting Events

Select any event from among the following:

NONE — releases the event/action setting.

REMOTE

- This menu is displayed only with the DI/DO modules that are recognized as system modules.
- When a remote control signal is applied, the action is executed.
- There are 12 control signals available. Select any control signal from these numbers for event setting. Remote control signal terminal numbers are applicable for this selection.

ALARM

If an alarm occurs, the action is executed.

RELAY

If the selected internal switch or relay is operating, the action is executed. When the alarm module or the DI/DO modules are not recognized as system modules, the relay is set to OFF.

CHART END

When the end of the chart is detected, the action is executed.

FILE END

When the end of file (the time when the writing operation is terminated and the file is closed) is detected, the action is executed.

TIMER

- If the selected timer's set time is up, the action is executed. Six timers are available. Select any from among these timers. See Section 4.15, "Setting Timers and Summer/Winter Time."
- In combination with the level action, the action is repeated alternately between executing and stopping each time the timer's set time is up.

MFUNC KEY

- When the M.FUNC key on the operation panel is pressed, the action is executed.
- In combination with the level action, the action is repeated alternately between executing and stopping each time the M.FUNC key is pressed.

MATCH TIME

Match time setting allows you to preset a time to start/stop event/action functions. Set the Action you want to happen in the Action setting space.

Match Times Setting

- There are three types of applicable Match Times. Select any of them in the Match time dialog box on the right of the event/action setting screen. Select the day and time you want the Match Time event to occur. If the day is set to 0, events will occur every day at the set time.
- In combination with the level action, the corresponding action is repeated alternately between executing and stopping for each set time.

Selecting Edge or Level Action

Edge action (EDGE)

This action is executed when an event is detected.

Level action (LEVL)

This action is executed when an event is detected. When an event is released, this action will be canceled.

- An edge action and a level action cannot be set at the same time.
- For a level action, only one setting can be made.

Selecting Actions

Actions may be selectable depending on earlier Events and Edge/Level action settings. The following describes all available actions:

ALARM ACK

This allows alarm acknowledgment.

ALARM RST

Resets alarms. When the "RELAY" is selected for an event, this function cannot be selected.

TIMER RST

Resets timers.

RECORD (DR only)

- ON: Starts recording. The recording format is set individually.
- OFF: Stops recording. The level action does not include record ON/OFF functions.
- When the level action is set, the ON/OFF functions using the RECORD key are disabled.
- The edge and level actions cannot be set simultaneously.
- For the level action, only one action is available.

MANUAL PR (DR only)

Enables manual printing.

DIGITAL PR (DR only)

- Digital printing starts in the analog trend mode. The recording intervals depend on the timer setting (see Section 4.15). When the event/action functions are set, normal digital print functions are disabled.
- Only one setting can be made in the event/action function.

MSG PR (DC100, and DR only)

- Prints messages.
- Select any message from the corresponding codes 01 to 20.

MSG DISP (DC100, and DR only)

- Displays messages.
- Select any message from the corresponding codes 01 to 20.
- To cancel the message display, press any key.

SPEED CHG (DR only)

- Changes chart speed 1 to chart speed 2. When the recording interval is set to automatic (see Section 4.16), the recording interval is also changed. When the event is released, the chart speed and recording interval return to their original positions.
- Only one setting can be made in the event/action function.

GR TREND (DR only)

- This executes the recording in a channel in which the group setting has already been made. For this, set the dot-recording to "GROUP" and start recording by key operations following the "RECORD" given above.
- Select any group from G01 to G07.
- Only one identical group can be set in the event/action functions.

Note

- If Chart End appears, counter-actions such as RECORD ON are not executed.
 - Actions such as RECORD or SPEED CHG may operate later than an event occurrence. For example, with RECORD set in the action setting, if an alarm occurs, the measured values in that condition are not recorded. This is because recording operations are delayed due to an action operation.
-

MATH (for instruments with /M1 option or FDD option only)

- START: Starts computation.
- STOP: Stops computation.
- RESET: Resets computation channel data at the end of completion of the first computation in case an event takes place.
- CLEAR: Resets computation channel data immediately in case an event takes place.
- If MATH is selected as a level action, computation will be carried out while an event is present. Computation will stop when the event is cleared.

MEMORY (for DC100, and DR with FDD option only)**DR with FDD option**

- DATA_WR : Saves a data item each time an event occurs, until the specified data length is reached.
- WR_TRIG : Saves measured/computed data on the built-in RAM disk.
- RD_TRIG : Reads measured/computed data from the built-in RAM disk.
- LD_TRG1-3 : Reads setup data from the built-in RAM disk.

DC100

- DATA_WR : Writes the data for one scan (one data/channel) retained at the generation of an event. To execute this, it is necessary to set LOGIC to the writing period.
- TRIG : Generates a trigger to start writing. To execute this, it is necessary to set TRIG to WRITE TRIG.
- START : Opens a file and starts the writing operation. It is the same function as the START key on the operation panel.
- PAUSE : In the case of edge action, writing is suspended at the generation of an event. In the case of level action, by setting the alarm, remote, relay or internal switch to the event, writing is suspended at the detection of an event and resumes at the resetting of the event (see the following figure). Setting the timer, match time or manual function key to the event repeats suspension and resumption of data writing at the generation of each event.
- CP_FDD : All files in the built-in RAM disk are copied on a floppydisk. Whether to cancel files after copying or not depends on the setting in the MEM SET of the SET UP menu. Copying after a conversion to ASCII format cannot be done.
- CP_SCS0 to CP_SCS7 :
All files in the built-in RAM disk are copied on a MO, ZIP or PD. Whether to cancel files after copying or not depends on the setting in the MEM SET of the SET UP menu. Copying after a conversion to ASCII format cannot be done.
Displayed only on models with the C/5 option. SCS0 to SCS7 represent the SCSI ID numbers. Check the ID numbers of SCSI devices that are connected, because ID numbers are displayed even if there are no devices connected to them.

FLAG (only for Math option models; DC style number. 7+, DA100/DR style number 8 or higher)

- F01 to F16: Set the flag number (F01 to F16) to 1. F01 to F16 are normally 0. Flags can be placed in computing equations to hold the computed result using a certain event as a trigger, or reset to 0.

4.14 Event/Action, Match Time, and Group Settings

FLOPPY

- LD_TRG1-3: Reads setup data from the floppydisk.

SCSI0 to SCSI7 (for DC100 with /C5 option only)

- LD_TRG1 to 3: Read set-up data from the SCSI device (MO, ZIP or PD).
SCSI0 to SCSI7 represent the SCSI ID numbers. Check the ID numbers of SCSI devices that are connected, because ID numbers are displayed even if there are no devices connected to them.

REPORT (available if the instrument is equipped with the REPORT function.)

- START (Edge action): Starts making up a report.
- STOP (Edge action): Stops making up a report.
(No Start/Stop for Level action)
Basic Setup for hourly, daily, or monthly report function must be ON.
- REPORT (Level action): Starts/stops making up a report.

Note

If, in the SETUP mode, the report function is set to OFF for all data items, you cannot select the action item REPORT.

Groups Setting

Make Group settings for DR group trend recording or for group computation statistics, in the setting screen on the right side of the Event/Action setting screen.

4.15 Setting Timers and Summer/Winter Time

Setting Timers

The Timer function can be used to trigger a number of event/action functions. It can also set the time interval between digital printouts of analog values, or between logging printouts.

- 1 Click the Event/Action tab, or select Settings > SET (Regular) Settings > Timers from the menubar. The Timers setting screen will open.

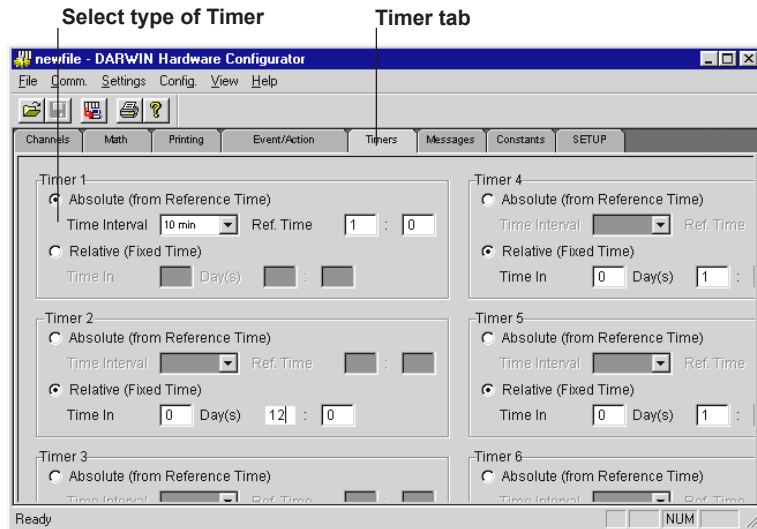

- 2 Select the kind of Timer, Absolute (from the reference time), or Relative (a fixed time). See the below illustration.
- 3 If you choose to set an Absolute time, set the desired time interval, and a reference time. If you select a Relative time, set the fixed amount of days, hours, and minutes you would like between events. Event detection occurs every specified time interval. Six timers can be set. They are reset with an action.

• Absolute time setting

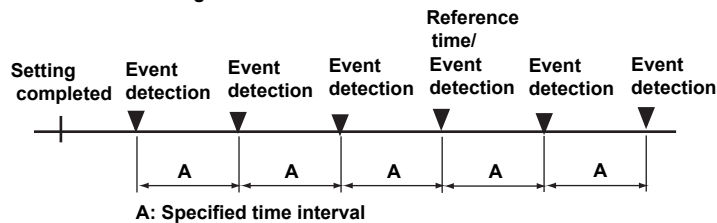

• Relative time setting

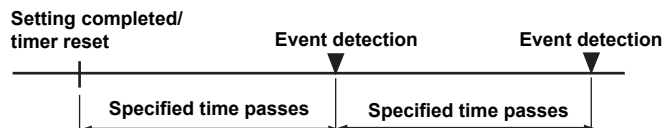

4.15 Setting Timers and Summer/Winter Time

Summer/Winter Time

If your hardware device is equipped with the /L1 option it is possible to let the hardware automatically change its date and time to summer or winter time when appropriate. If you specify Summer Time the time will be adjusted to one hour later when the specified date and time is reached. If you specify Winter Time, the time will be adjusted to one hour earlier when the specified date and time is reached.

Make sure the Summer/Winter Time option is activated in the System Configuration setting screen.

- 1 Click the Event/Action tab, or select Settings > SET (Regular) Settings > Timers from the menubar. The Timers and Summer/Winter Time setting screen will open.
- 2 Set the date and time.

Note

- Don't set timezones using the Windows system autoexec.bat. (Place the REM command before commands like TZ=GMT0 for autoexec.bat.) To set timezones select the required timezone in the Windows OS Date/Time Properties setting screen (Start Menu > Settings > Control Panel > Date/Time), and check the "Automatically adjust clock for daylight saving changes" checkbox.
 - In the Windows OS Date/Time Properties setting screen (Start Menu > Settings > Control Panel > Date/Time) always make sure to check the "Automatically adjust clock for daylight saving changes" checkbox, even if you do not wish to use daylight saving changes for DAQ 32 Plus software. If you don't check the setting, errors may occur for the DARWIN Daylight Saving Time function.
-

4.16 Printing Settings (DR Only)

The following print setting can be made for DRs:

- Recording Mode (Trend or Logging)
- Trend Printing interval (Fixed or Automatic)
- Chart speed
- Chart speed 2
- Header
- Title
- List Format

To open the Printing related setting screen (see below), click the Printing tab, or select Settings > SET (Regular) Settings > and either Recording Mode, Chart Speed, Chart Speed 2, Header, Title, or List Format, from the menubar.

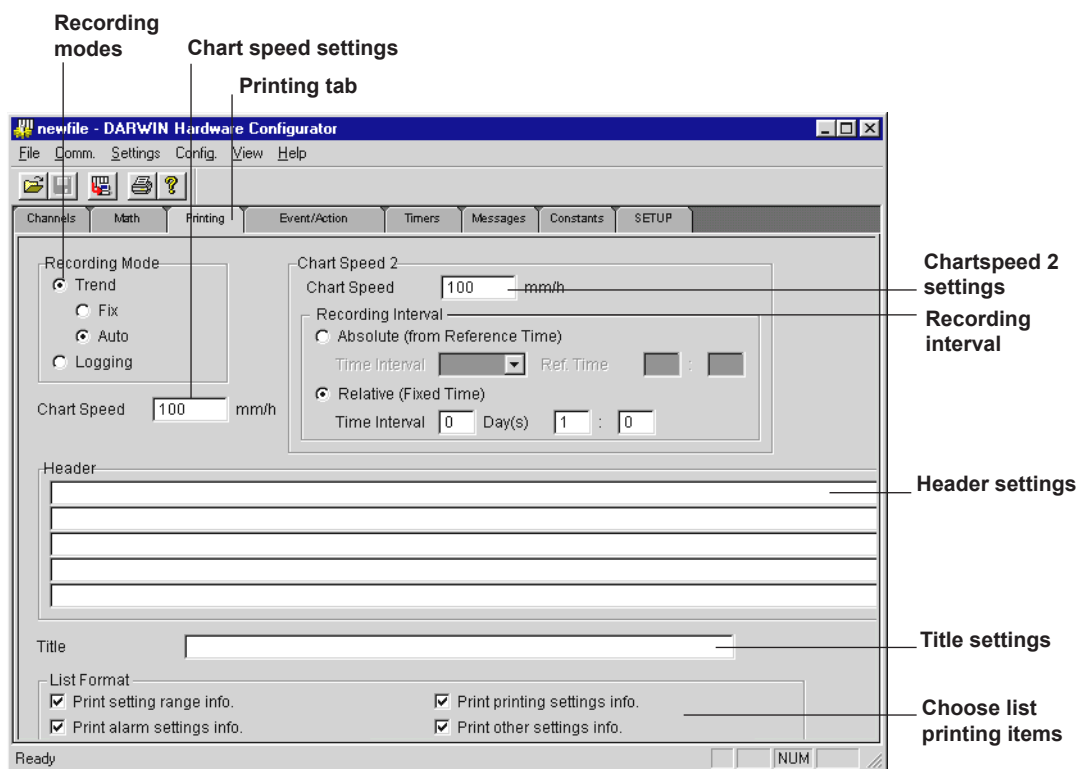

Recording Mode Settings

The following types of recording mode can be selected.

- LOGGING (LOGGING MODE) : measurement values will be printed out as digital values.
- TREND (ANALOG TREND MODE) : measurement values will be recorded as analog trends (dot recording) and printed out as digital values.
- Selecting the recording interval
This setting can only be done for the TREND mode.
FIX : Recording takes place at intervals equal to the measurement period (scan interval). However, if the measuring period is 0.5 or 1 second, the recording interval is fixed to 2 seconds. The measured data during the excess period is ignored.
AUTO : recording takes place at intervals automatically decided by measurement interval and chart speed.

Chart Speed Settings

Chart Speed 1 (CHART)

This setting specifies the chart speed of ordinary trend recordings. The setting ranges from 1 to 1500mm/h, in 1 mm steps. The default setting is 100mm/h.

Chart Speed 2 (CHART2)

This setting consists of a chart speed and recording interval. Depending on the Event/Action function, the chart speed and recording interval will change into chart speed 2 and its corresponding interval.

- Chart speed 2 setting
This setting is the same as for chart speed 1, and its default setting is 100mm/h.

- Recording interval
This setting specifies the recording interval for the digital printout in the logging and analog trend recording mode. Set either the Absolute or Relative interval

If the SPEED CHG action is selected as event/action setting, the Recording Interval will be change as follows:

Trend Recording

- Normal: Speed set as Chart Speed 1
- When an event occurs: Speed set as Chart Speed 2

Logging Recording

- Normal: Depends on the (SETUP) Recording Format settings for the Recording interval in digital printing/logging. It can be set to Single or Multiple:
 - Single- Interval for timer one.
 - Multiple- Intervals selected from 6 kinds of timers.
- When an event occurs: Interval set as Chart Speed 2.

Entering a Header

HEADER LINE No.: One header can consist of up to five lines.

LINE 1 to 5: The header contents can be entered here using up to 80 alphanumeric for each line, and thus up to 400 characters for the entire header. The default setting is all spaces. To print the header press the Print button on the DR and select HEADER START from the menu.

Entering a Title

One title can be set, using up to 32 alphanumeric. Set the Title printing pitch to 600 mm, 1500 mm or set it OFF, in the (SETUP) Recording Format setting screen.

Setting the List Format

The List Format (LIST FMT) setting specifies which setting information will be printed out in case of list printouts. Each of the following lists can be selected ON or OFF, and the default setting is ON.

Print setting range info: Information about settings related to tags, type of input, recording span, linear scaling and computation equation.

Print alarm settings info

Print printing settings info (LIST PRINT) : Information about settings related to analog trend recording, digital printout, interpolation, recording zones, partial expanded recording, recording interval of digital printouts for logging mode and analog mode, moving average, scaled values, alarm printout, manual printout and data saving ON/OFF.

Print other settings info: Information about settings related to match time, groups, headers, messages, event/action function, list format and computation constant.

Information which always be included in a list printout, regardless of the above settings, are title, measurement interval, recording interval (trend), chart speeds 1 and 2, recording mode and time.

4.17 Setting Messages (DC100, DR only)

Messages can be printed out on the occurrence of an alarm, instantly using the FUNC menu, or as an event/action setting.

- 1 To open the Messages setting screen, click the Messages tab, or select Settings > SET (Regular) Settings > Messages from the menubar.

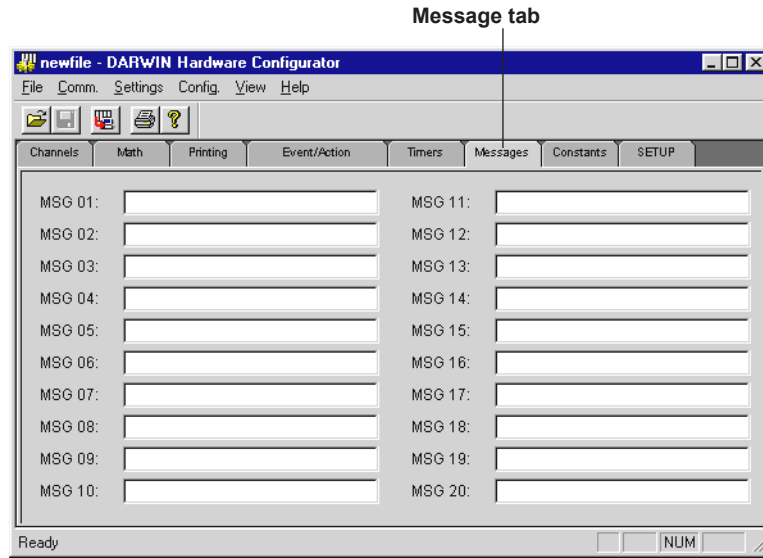

- 2 Enter messages with maximum 16 alphanumeric.

4.18 Setting the Writing Operation (DC100 Only)

To open the Writing Operation setting screen (see below), click the Writing Operation tab, or select Settings > SET (Regular) Settings > Writing Operation from the menu bar. :

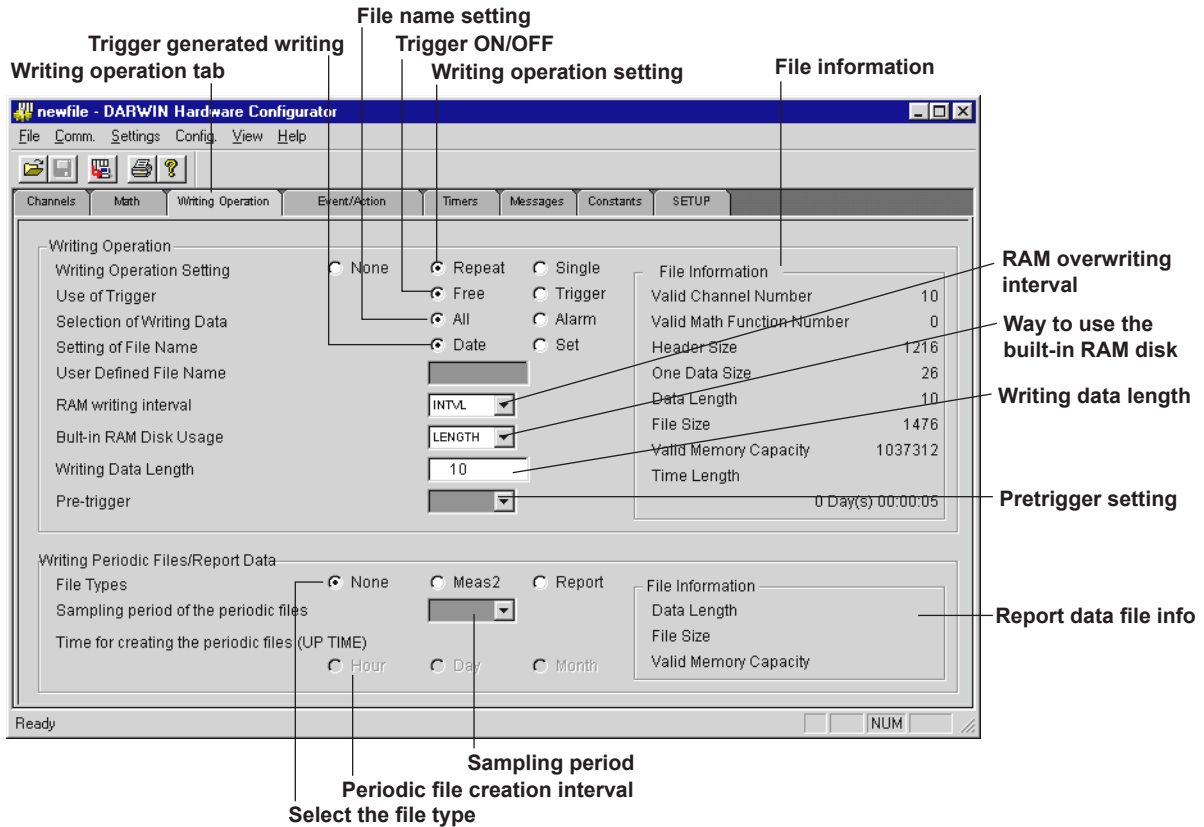

Writing Operation Setting (WRITE MODE)

Select the writing operation of the measured/computed data from the following:

- **None:** Displayed only when the /M3 option is installed. Use this mode when saving only report data or periodic files. The entire built-in RAM disk is used for saving these files. If there are files saved on the built-in RAM disk, you cannot change the operation from None to Single or Repeat or visa versa.
- **Single:** Data for only one file are written and then the writing operation is terminated.
- **Repeat:** After writing data for one file is completed, the next file is created and writing starts. When the built-in RAM disk becomes full, the writing operation is terminated. However, if the WRITE MEMORY setting is DIV, when the built-in RAM disk becomes full, the file with the oldest date and time is deleted and new data items can also be continued to be written by setting FILE ROTATE to ON in the SETUP (Basic) mode.

Use of Trigger (WRITE TRIG)

Writing can be set to be started when an event (trigger) is generated.

- **Trigger:** Writing starts at the generation of an event (trigger) using the event/action function (trigger mode).
- **Free:** Writing starts when the Start key is pressed.

Note

If data are written using TRIG, the saving operation is also required to start using the START key or through the event/action function.

Selection of Writing Data (WRITE DATA)

Select the data to be written from the following:

- All : All measured/computed data are written.
- Alarm : Measured/computed data in all channels are written only when an alarm is generated.

Setting of File Name (WRITE NAME)

- Select the specifying method of a file name from the following:
 - Set : Freely set by the user (up to 5 characters). Characters that can be used for file names are only those that can be selected from the display; no blanks allowed.

All letters will automatically be capitalized.

- Date : Automatically set based on the date.

When Date is selected, the file name is set automatically in the following form:

Form of file name (at automatic setting)

6 1 0 1 0 0 0 0 . D A T

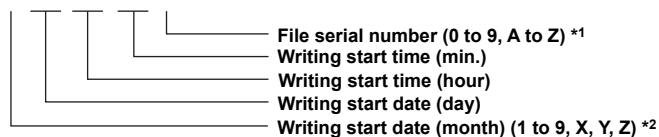

*1 The serial numbers 0 to 9 are followed by A to Z, and return to 0 after Z.

*2 X, Y, and Z represent October, November, and December respectively.

File name format (when specified by the user.)

FILE - 0 0 1 . D A T

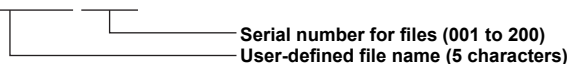

- Serial file numbers are automatically changed only when writing is done continuously with the same name.
- If a file with serial number 200 exists during writing in the SINGLE mode, this serial file number is not automatically changed. Rather, the file is given a name with serial number 001.
- If the same file names exist, whether to employ overwriting or to end writing can be set in the SET UP menu.

Writing Period

- The period in which data are written can be selected from the following:
 - INTVL: The same as the measuring period. Measured/computed data are saved without thinning-out.
 - 1, 2, 3, 4, 5, 6, 10, 12, 15, 20, 30 seconds, or, 1, 2, 3, 4, 5, 10, 30, or 60 minutes: Writing is done with the set period.
However, only those values which are multiples of the measuring period can be selected.
 - LOGIC : Only effective if event/action is set to action DATA_WR. Every time an event is generated, the data item for 1 scan (1 for each channel) is written.
- If the computation channel is used, missing computation measurements may occur depending on the number of computation expressions or measuring period. If the computation measurement missing status is displayed, make the measuring period longer or decrease the computation expressions.
- When the measuring period is changed, the writing period will not equal the measuring period or its integral multiples, and is subsequently adjusted to equate with the measuring period.

4.18 Setting the Writing Operation (DC100 Only)

Built-in RAM Disk Usage (WRITE MEMORY)

- Select the built-in RAM disk usage from the following:
 - LENGTH: Determines file capacity by specifying the number of data items per ch.
 - DIV2, DIV4, DIV8, or DIV16: Use the RAM disk by dividing the disk area into 2, 4, 8 or 16 parts. If the memory capacity is 4 MB, 2 cannot be used.
- If a file is saved in the built-in RAM disk, the usage of the built-in RAM disk cannot be changed. For this purpose, initialize the RAM disk or change the setting after deleting all the files. In that case, necessary files must be saved on a floppydisk.

Writing Data Length (WRITE LENGTH)

- If WRITE MEMORY is set to LENGTH, set the number of data items to be written per channel, selecting from the following: 10, 20, 30, 40, 50, 100, 200, 300, 400, 500, 1k, 2k, 3k, 4k, 5k, 10k, 20k, 30k, 40k, 50k, or 100k
- However, a data length exceeding a file size of 1 MB cannot be selected depending on the number of channels.
- After starting writing, even if the writing is stopped before the specified data length is reached, the file capacity is taken by the area for the specified data length.

Note

When using the computation channel, do not write measured/computed data in an application where the measurement interval is shorter than 0.5 sec, the writing interval is set to INTVL, or the data length is shorter than 50, if:

- the writing action is in the REPEAT mode.
 - writing starts using the event/action mode.
-

Pretrigger (WRITE PRETRIG)

- If WRITE TRIG is set to TRIGGER, the data before the trigger (event) generation can be saved in part of the set file. Setting is done as a percentage of the file capacity in 10% increments.

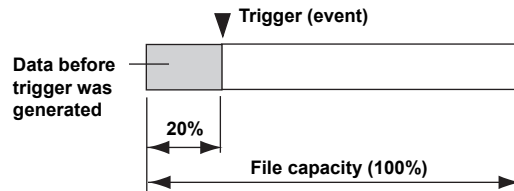

- If a pretrigger is used (except 0%), it is necessary to set the writing start trigger (WR_TRIG) to the action in the event/action function.

Data Format

The measured/computed data are saved in the binary format.

Data Capacity

The data capacity is determined by the following formula:

Measured data: 2 bytes/data item; Computed data: 4 bytes/data item.

- Stand-alone model: Header 256 + 64 x (number of measuring channels + number of computing channels) bytes. Data capacity = 256 + 64 x (number of measuring channels + number of computing channels) + (number of measuring channels x 2 + number of computing channels x 4 + 6) x data length.
- Expandable model: Header 576 + 64 x (number of measuring channels + number of computing channels) bytes. Data capacity = 576 + 64 x (number of measuring channels + number of computing channels) + (number of measuring channels x 2 + number of computing channels x 4 + 6) x data length.

4.19 Setting A/D Converter Integration Time, Filter, and Scan Interval

Open the A/D Converter Integration Time, Filter, and Scan Interval setting screen (see below) as follows:

Click the SETUP tab and select Interval from the SETUP (Basic) Setting contents box, or select from the menubar Settings > SETUP (Basic) Settings > and then either, A/D Converter Integration Time, Filter, Scan Interval, or File of Retransmission Output.

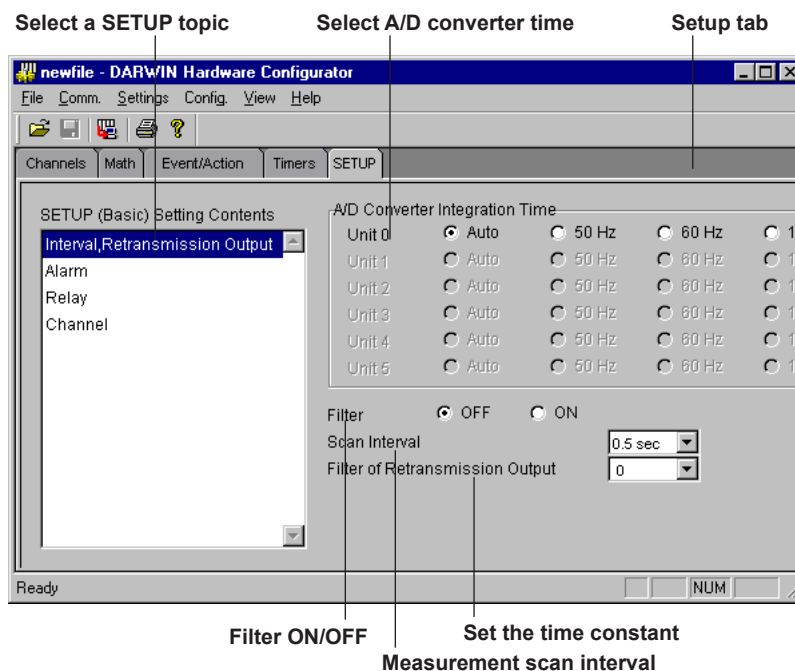

A/D Converter Integration Time

Select the A/D converter integration time for each unit. Select it from the following:

- Auto: the frequency of 50/60 Hz is automatically switched corresponding to the power frequency of this instrument. Note that Auto does not function for the stand-alone DC power supply model or for extended types using a DC power supply subunit.
- 50 Hz: the integration time is set to 20 ms (50 Hz).
- 60 Hz: the integration time is set to 16.7 ms (60 Hz).
- 100 ms: the integration time is set to 100 ms (10 Hz)
- The default setting is AUTO. However, if the instrument is a stand-alone DC power supply model, the default setting is 20 ms (50 Hz).

Filter

Set the filter to reduce normal mode noise, ON or OFF.

Scan Interval

- The duration of time (one scan) in which the measurement of all channels is carried out, is called the scan interval.
- This interval can be set to any value from 0.5 second to 60 seconds. The shortest is 40 ch/500 ms for the stand-alone model, or 300 ch/500 ms for the expandable model (varies with the shortest measurement period of the input module).

File of Retransmission Output

Set the time constant for abrupt changes in voltage or current being output from the transmission output module.

Choose a transmission output time constant from the pull down menu. The setting values and corresponding time constants are as follows:

Value	Time Constant (ms)	Value	Time Constant (ms)
0	4	5	250
1	12	6	500
2	28	7	950
3	60	8	1750
4	125	0	3000

Note

The time constant is for changes from 1 to 5 V, and 4 to 30 mA. If that change is smaller, the actual time constant will be smaller than the set time constant.

4.20 Setting Alarm Interval, Hysteresis, and Alarm Display Hold

Open the Alarm Setup setting screen (see below) for Alarm Interval, Hysteresis, and Alarm Display Hold as follows:

Click the SETUP tab and select Alarm from the SETUP (Basic) Setting contents box, or select from the menubar Settings > SETUP (Basic) Settings > Alarm Setup.

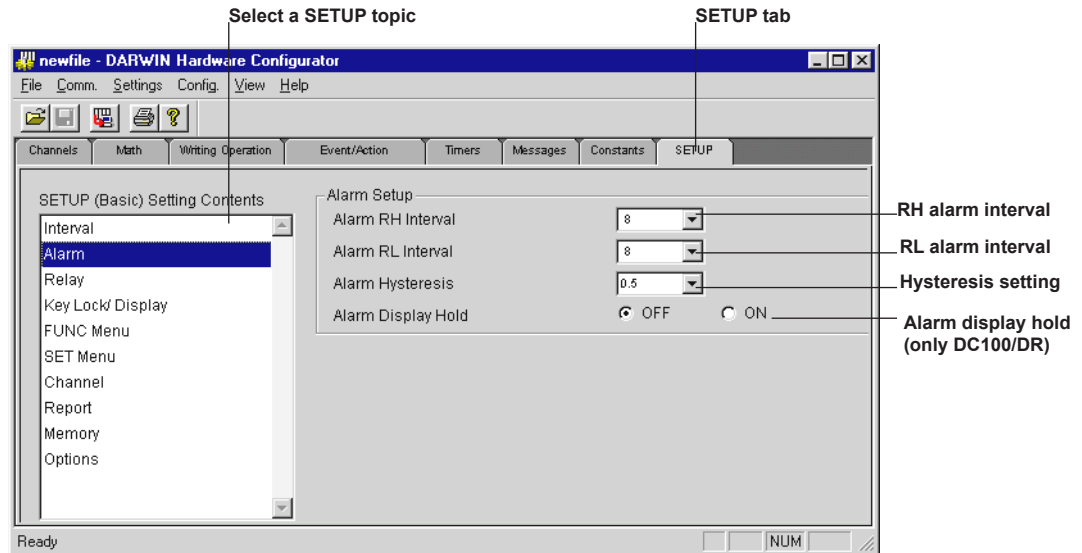

Alarm Interval

For high/low limit on rate-of-change alarms, variation is measured over a preset interval. If the variation exceeds the preset value, an alarm occurs. This interval can be set and applied to all channels.

Hysteresis

Set the width between the value of alarm occurrence and its release. This setting prevents frequent alarm occurrences/releases in an unstable environment. Hysteresis values can be set in the 0–1% percentage range of the span. The hysteresis setting is used for high and low limit alarms.

Set the span percentage using the Alarm Hysteresis pull-down box.

Alarm Display Hold (DC100, and DR only)

For DC100, and DR select whether to hold the alarm indicator after the alarm is released, or not.

4.21 Setting Relay and Internal Switch Actions

Open the Alarm Setup setting screen for Relay and Internal Switch Actions as follows: Click the SETUP tab and select Relay from the SETUP (Basic) Setting contents box, or select from the menubar Settings > SETUP (Basic) Settings > Relay > and the desired relay setting.

Select a SETUP topic Reflashing Alarm Relay AND/OR SETUP tab

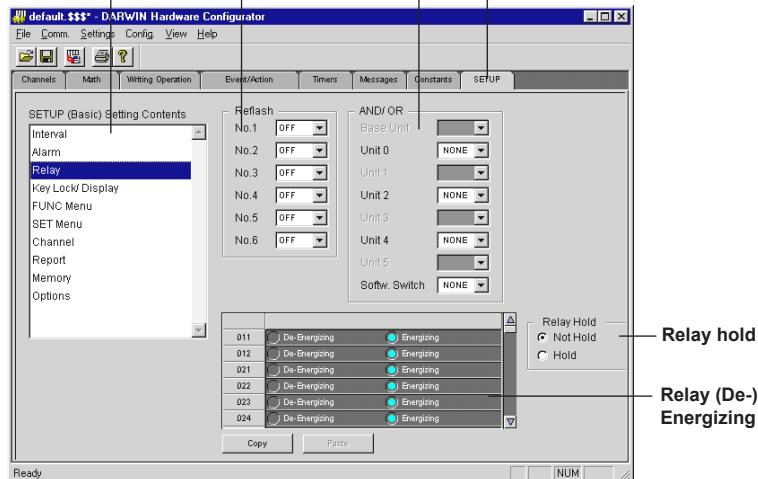

Reflashing Alarm Setting

When several alarms share the same alarm output relay, you can select this setting which results in a short de-operation of the relay when a second alarm occurs.

Relay AND/OR

Select how the internal switches/alarm output relays will be operated, when a group of alarms share the same internal switch or alarm output relay.

AND : will be operated when all alarms are occurring;

OR : will be operated when at least one alarm is occurring.

Use the pull-down menu to select AND settings in a range starting from relay 1, or choose NONE for all OR actions.

Relay (De-)Energizing

Select alarm output relays to be energized or de-energized on alarm occurrence. A blue circle in the (De-)Energizing dialog box marks the active setting.

Copy Relay (De-)Energizing settings by clicking the number of the settings you want to copy to other channels. The display color changes. Click the copy button in lower left corner of the setting screen. Click the first channel you want to copy the settings to, and drag the mouse pointer down to the last channel the settings should be copied to. The display color of the selected channels changes. Click the Paste button, to copy the selected settings to the selected channels.

Relay Hold Setting

Select whether to Hold, or Not Hold, the operating status of operated internal switches or alarm output relays. This setting applies to both the internal switches and the alarm output relays.

DO External Relay Setting (DA100 only)

For DA100 you may also use the Command DO to set Relays externally (with a PC) ON or OFF. The relay is set from the Base unit to each complete module. If the relays set here are alarm output relays, then normal alarm output relays in the same will be set OFF.

4.22 Setting Burn-out, RJC, and (for DR Only) Recording Colors

Open the Alarm Setup setting screen (see below) for Burn-out, Reference Junction Compensation, and (for DR Only) Recording Colors as follows: Click the SETUP tab and select Channel from the SETUP Setting contents box, or select from the menubar Settings > SETUP (Basic) Settings > Relay > and Burn-out, RJC, or Recording Colors.

Select a SETUP topic Burn-out setting Select RJC SETUP tab

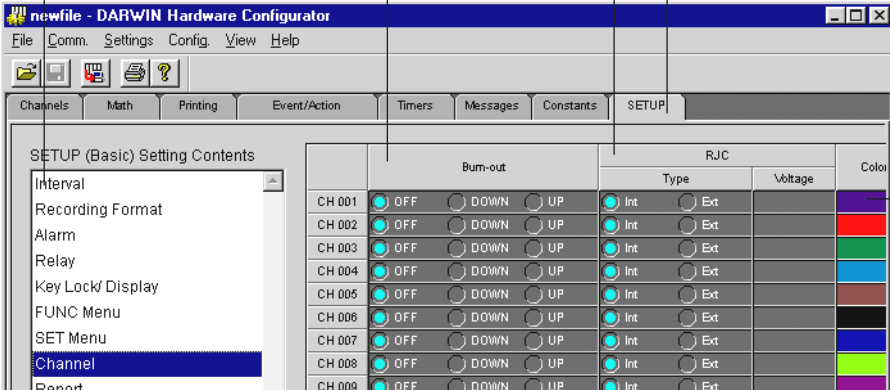

Recording color (for DR only). Click a color to display the color dialog box.

Copying Settings

Copy below settings to other channels as explained in Section 4.12.

Burn-out

Set the recording position for each channel when burn-out occurs. Click OFF, DOWN, or UP. A blue circle marks the active setting.

- OFF : The burn-out function is not actuated.
- DOWN : The output extends to the minimum value of the span.
- UP : The output extends to the maximum value of the span.

Reference Junction Compensation (RJC)

Set either the internal or the external compensation for each channel in the RJC Type setting space. A blue circle in the Burn-out setting area marks the active setting.

- INT : internal compensation is performed.
- EXT : external compensation is performed. For external compensation, set the voltage to be compensated in the RJC Voltage setting area. Voltage to be externally compensated: set in the range of -20000 to 20000 μV .

Recording Colors (for DR only)

To set the colors used for DR trend recording, click the color setting area to display the Recording Colors setting screen. Select the desired channel color and click OK.



4.23 Report Settings

Open the Report setting screen as follows:

Click the SETUP tab and select Report from the SETUP (Basic) Setting contents box, or select from the menubar Settings > SETUP (Basic) Settings > Report > and either Report Setting, Report Channel, or Report printing.

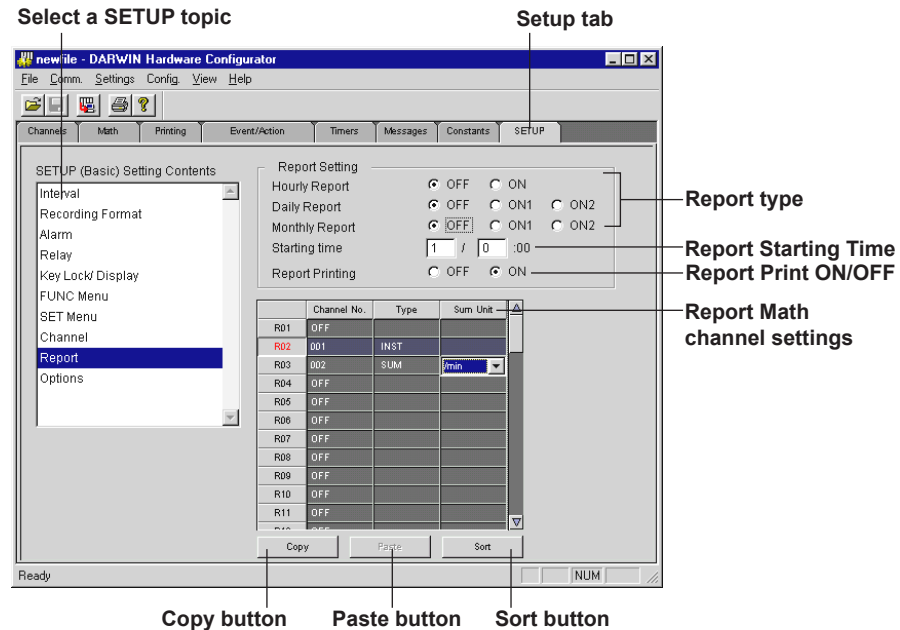

Report Time and Format

Set hourly, daily and monthly types of report making, OFF or ON. It is possible to set hourly, daily and monthly report all ON at the same time.

File Formats

The format of the report file is available in either the standard (ON1) or enhanced (ON2) format. Hourly reports can have the standard format only.

- Standard format (ON, ON1): Outputs the Math results on a report-channel basis.
- Enhanced format (ON2):
 - Daily reports : Math results configured on a report-channel basis plus hourly information on the Math results given at each preset time.
 - Monthly reports : Math results configured on a report-channel basis plus daily information on given simultaneously with the preset time for making each report.

Type	Intervals Between Making Reports	Data Item for Computing
Hourly report	Every hour (1:00, 2:00 . . . , 23:00, 24:00)	An hour's average, maximum and minimum An hour's sum and cumulative sum Instantaneous value at the time of making the report
Daily report	Every other day (preset time)	A day's average, maximum and minimum A day's sum and cumulative sum Instantaneous value at the time of making the report
Monthly report	Every other month (preset time)	A month's average, maximum and minimum A month's sum and cumulative sum Instantaneous value at the time of making the report

Report Printing ON/OFF

Set whether the report should appear on print (ON) or not (OFF).

Report Starting Time

Set the Starting Time in the format day of month : time. Define the day of month field within a 01-28 range and the time field within a 00-23 range.

Report Channels

There are sixty report channels, from R01 to R60. Assign channels for measuring objects being computed or Math channels and the type of Math on a report-channel basis. When making a Math report, let computing start before making the report start.

Types of Computing

Select one of the below:

Type	Data Item for Computing (Math)
INST	Instantaneous value at the time of making report
AVE	Average, maximum and minimum over the computing period
SUM	Sum and cumulative sum over the computing period

Sum: The total sum over an hour for hourly reports, the sum over a day for daily reports or the sum over a month for monthly reports. The instrument resets this value each time it makes any of these reports.

Cumulative sum: The total sum up to the preset time to make a report in the case of hourly reports or the sum up to a preset time of the day to make a report in the case of daily reports. The instrument resets this value at each preset time or at each preset time of the day for report making. The instrument does not perform cumulative summation for monthly reports.

Unit of Summation (Sum Unit)

Input data items like flow rates, that have a unit in /sec, /min, /hour or /day, give Math results that differ from their actual values when simply summed. This occurs because the unit of such a data item differs from that of the measurement interval.

In such cases, take the output after having converted the Sum Unit so it matches that of the input data item applied.

Unit of Input (Preset Unit)	Conversion Formula
INTVL (no conversion)	\sum (measured data values)
/sec	\sum (measured data values) \times measurement interval
/min	\sum (measured data values) \times measurement interval/60
/hour	\sum (measured data values) \times measurement interval/3600
/day	\sum (measured data values) \times measurement interval/86400

Copying settings

Channel No., Type, and Sum Unit settings can be copied to other channels as explained in Section 4.11, "Copying Channel Settings."

Sorting the channel order

It is possible to automatically sort report channels following each other up from a report base channel.

For example, if Report channel R03 is object for channel 005, report channels R04 and up, will automatically become object for channels 006, 007, 008, ...etc.

To sort the channels, click the report channel from which up you want channels to be sorted and drag it down. Click sort to start sorting.

4.24 Setting (TLOG) Math Setup, Temperature Unit, and (DC100 only) SCSI ID Number

Click the SETUP tab and select Options from the SETUP (Basic) Setting contents box, or select from the menubar Settings > SETUP (Basic) Settings > and either Math Setup, SCSI ID, or Temperature Unit.

The below setting screen appears.

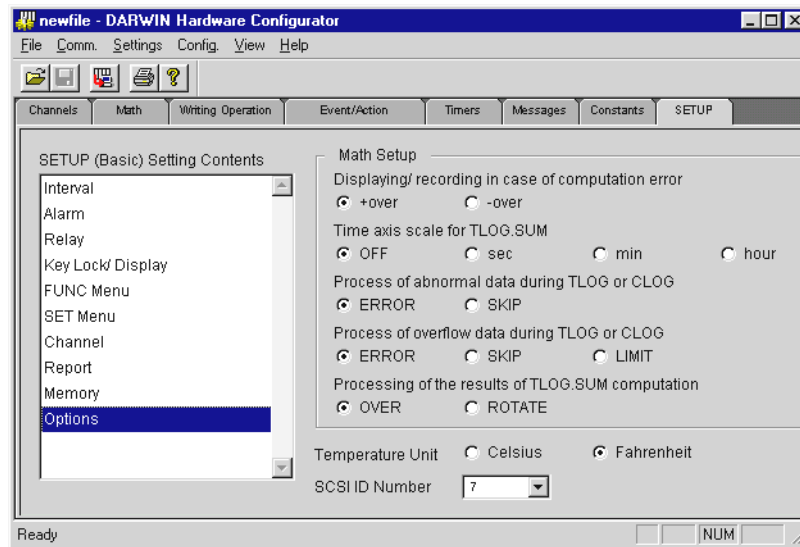

Math Setup

Displaying/recording in case of computation error

Used to determine whether +OVER or -OVER be displayed/saved in case of computation error.

Time axis scale for TLOG SUM

For TLOG.SUM of time series, data is added at each measurement interval. However, in the case of an input having unit of /s, /min or /h like flow rate, the computation result will differ from the actual value, if addition of data is carried out. In this case, setting TLOG TIME SCALE according to the unit of the input will cause the data measured at measurement intervals to be processed according to the unit of the input.

For instance, if the measurement interval is 2s and input value is 100 m³/min, the computation result will be 30000 after the elapse of one minute, since 100 is added every 2 seconds. Setting TLOG TIME SCALE to /min will cause the measured data to be multiplied by 2s/60s at each measurement interval, thus making the result close to the actual input value.

If this function is set to OFF, simple addition of data will be carried out.

Process of abnormal data during TLOG or CLOG (TLOG CH ERROR)

Used to select the process method for abnormal data obtained during TLOG or CLOG.

- ERROR : Abnormal data processed as a computation error.
- SKIP : Abnormal data ignored and computation is continued.

Process of overflow data during TLOG or CLOG (TLOG CH OVER)

Used to select the process method for overflow data obtained during TLOG or CLOG.

- ERROR : Overflow data processed as a computation error.
- SKIP : Overflow data ignored and computation is continued.
- LIMIT : Overflow data treated as the next data for computation.

Measurement channels to which linear scaling is applied: Specified scaling upper-/lower-limit.

Measurement channels to which no linear scaling is applied: Upper-/lower-limit of the measuring range.

Computation channels: Specified LEFT/RIGHT value.

Processing of the results of TLOG.PSUM computation for pulse input

- OVER : If the result of a separate calculation of TLOG.PSUM (XXXX) exceeds 99999999, the instrument goes into an overflow.
- ROTATE : If the result of a separate calculation of TLOG.PSUM (XXXX) exceeds 99999999, the instrument resets the value subsequent to 99999999 to 0 and continues computing. For example, if the measured data subsequent to 99999999 which has been reached is 3, the computed result becomes 2 by counting 0, 1 and 2.

The process is effective only when a pulse input module is installed. This setting cannot be made for a DR standalone type

Temperature Unit (for /D2.. deg F Display only)

If your DARWIN hardware is equipped with the /D2 option it is possible to change the Temperature Unit (C/F) for TC and RTD.

Make sure to activate the Temperature option in the System Configuration setting screen, by checking the Temperature Unit Switch (/D2).

Note, that as soon as you select Celsius or Fahrenheit the SET (Regular) Settings will all be initialized. Therefore, make sure to switch the Temperature Unit before changing any SET (Regular) settings.

SCSI ID Number (for DC100 only)

Set the ID so that it does not overlap with other SCSI devices connected to the DC100. The default value is seven.

4.25 Setting FUNC Key, and SET Key Operations (for DC100, and DR only)

Click the SETUP tab and select FUNC Menu, or SET Menu from the SETUP (Basic) Setting contents box, or select from the menubar Settings > SETUP (Basic) Settings > and FUNC/FUNC3 Menu, or SET/SET3 Menu.

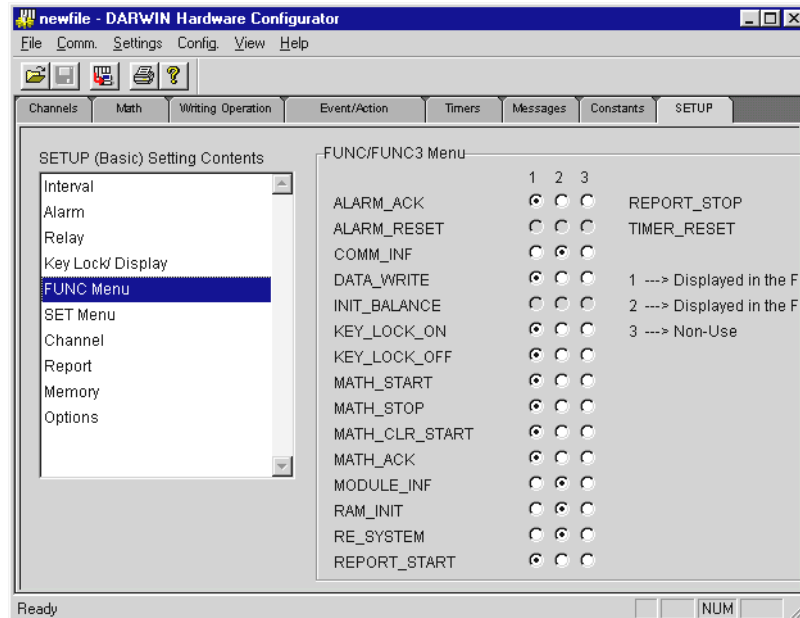

The below explanation is for the FUNC key. Set key setting works the same. Select the menu to be displayed by pressing the FUNC key whether in the FUNC menu or the FUNC3 menu.

The FUNC menu is displayed by pressing the FUNC key at a touch and the FUNC3 menu is displayed by pressing the FUNC key for about 3 seconds continuously.

Select one of the following three options using the radio buttons:

- 1 FUNC: displayed in the FUNC menu.
- 2 FUNC3: displayed in the FUNC3 menu.
- 3 OFF: not displayed in either menu.

Note

[OUTPUT] can be accessed with the SET key. When you select [OUTPUT], you can assign transmission output channels.

4.26 Setting the Recording Format (DR only)

Click the SETUP tab and select Recording Format from the SETUP (Basic) Setting contents box, or select from the menubar Settings > SETUP (Basic) Settings > Recording Format.

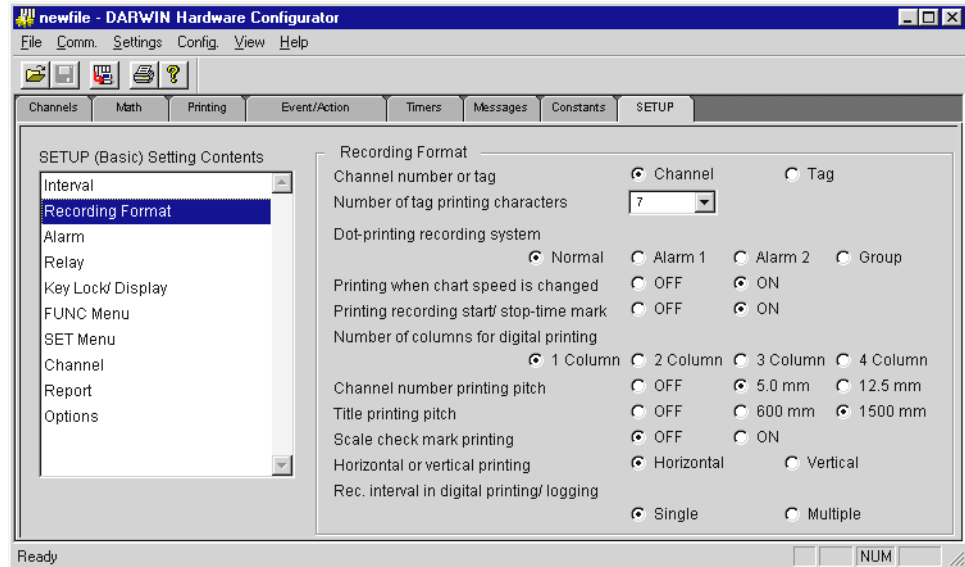

Channel number or Tag display

Select to print or display measured values using channel number labels or tag names.

- Select either Channel or Tag. Note that the channel number will be printed/displayed regardless of selection, if no Tag setting is made (or all spaces).

Number of Tag printing characters

Select 7, 8, 9, 10, 11, 12, 13, 14, 15 or 16.

- The default setting is 7.
- If the selected number of printing characters is less than the actually entered Tag, only the number of characters selected here will be printed.

Dot-printing Recording System

Select it from the following systems. The default setting is NORMAL. To practically record it, the RECORD must be turned on. Channels to be recorded are those selected to be ON in “Setting the Channels to be Recorded, Dot Recording” on page 6-2.

Normal:

- To record all object channels.

Alarm 1:

- To record only the channels with on-going alarm.
- Recording continues even if the alarm is released.

Alarm 2:

- To record only the channels with on-going alarm.
- Recording stops when the alarm is released.

Group:

- To record the channels which are set into a group only.
- Recorded only if “GR TREND” is set in the event/action function.

4.26 Setting the Recording Format (DR only)

Printing when chart speed is changed (SPEED CHANGE PR)

When the chart speed is changed in dot-recording, select whether to print with the changed chart speed or not.

- OFF : does not print.
- ON : prints.

Printing recording start/stop time mark (ON/OFF MARK PR)

In dot recording, select whether the record-start/stop time is printed or not.

- OFF : not printed.
- ON : printed.

Number of columns for digital printing (DIGITAL PR CLMN)

Select the amount of channels to be printed in one horizontal line.

- Select 1, 2, 3, or 4 columns.
- If Tag has been selected in selecting the channel number/Tag, this is limited to 3 columns. If Tag is set to 16 characters, the Tag entry is limited to two columns.

Channel number printing pitch (CHANNEL PITCH)

For dot recording, select the number of millimeters for the channel number printing interval. When Tag has been selected in channel number/Tag selection, the Tag corresponding to the channel number is printed.

- OFF : not printed.
- 5.0 mm : printed every 5.0 mm.
- 12.5 mm : printed every 12.5 mm.

Title printing pitch (TITLE PITCH)

For dot recording, select the title printing interval in millimeters.

- OFF : not printed.
- 600 mm : printed every 600 mm.
- 1500 mm : printed every 1500 mm.

Scale check mark printing (SCALE TIC PR)

For dot recording, a tic mark indicating the scale mark positions can be printed.

- OFF : no mark printing.
- ON : printing the tic mark.

Horizontal or vertical printing (LOG FORMAT)

In logging mode, select either horizontal or vertical printing of the channel number/Tag.

- Horizontal : horizontal printout
- Vertical : vertical printout

Recording Interval in Digital Printing/Logging Mode (LOG INTERVAL)

Select to record channel numbers/Tags and measured values at one interval or at a selected interval for each channel using the 6 timers.

SINGLE:

- Digital print : The interval is determined by the chart speed and the number of columns to be printed.
- Logging mode : interval for timer No. 1.

MULTIPLE : intervals selected for each channel from 6 kinds of timers for either Digital printing or the Logging mode.

4.27 Memory-related Settings (DC100 only)

To open the Memory Setup setting screen do as follows. Click the SETUP tab and select Memory from the SETUP(Basic) Setting contents box, or select from the menubar Settings > SETUP (Basic) Settings > Memory Setup.

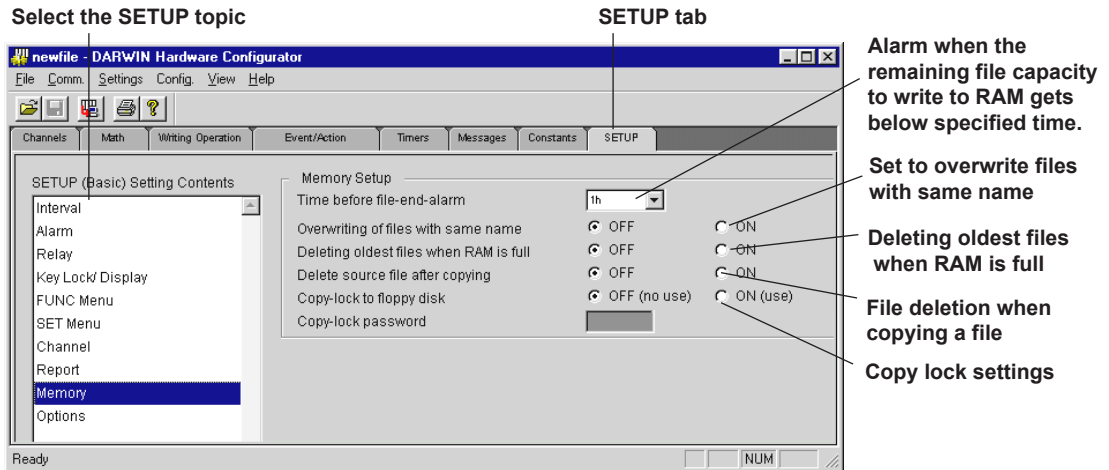

Time before file-end-alarm (FILE ALARM)

- This outputs a file alarm from a relay when the remaining file capacity becomes below the one corresponding to the specified time while the measured/computed data are being written in the built-in RAM disk. Select the remaining time from the following:
0h: Outputs an alarm when file has been created (file is closed).
1h, 2h, 3h, 4h, or 5h: Outputs an alarm when the remaining time reaches the specified time.

Overwriting of files with the same name (FILE OVERWRITE)

- When measured/computed data are written, if there is a file with the same name in the built-in RAM disk, set whether to overwrite the file or not.
ON: Overwrites the file.
OFF: Stops writing.

Deleting oldest files when RAM is full (FILE ROTATE)

- If saving with the division method and the saving operation is REPEAT, and if memory becomes full and so there is no file creation capacity, the saving operation is continued by deleting the file with the oldest date and time.
ON: Continues saving operation by deleting a file.
OFF: Terminates the saving operation.

File deletion when copying a file (FILE COPY & DELETE)

- Set whether a file in the copying source is to be deleted or not when copying a measured/computed data file to a floppydisk.
ON: Delete.
OFF: Do not delete.
ASCII-converted copying is not supported.

4.27 Memory-related Settings (DC100 only)

Copy-lock to floppydisk

- Select whether to use the lock function not for copying measured/computed data to a floppydisk.
OFF: No use. Password not needed,
ON: Use. Set a password.
Copy lock doesn't work for ASCII-conversion copying.

Copy-lock password

A password is needed if copy locking is used. Enter four numbers.

4.28 Setting Keylock, Display Update Interval, and Channel/Tag Display Indication (DC100/DR only)

To open the Keylock, Display Update Interval, and Channel/Tag Display Indication setting screen do as follows. Click the SETUP tab and select Key Lock/Display from the SETUP (Basic) Setting contents box, or select from the menubar Settings > SETUP (Basic) Settings > and either Key Lock, Display Update Interval, or Display Indication.

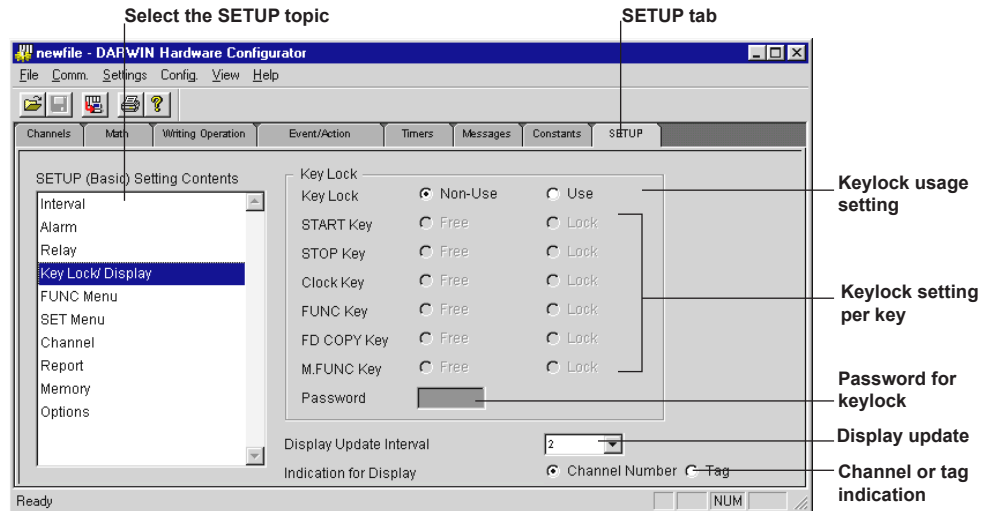

Key Lock

Selection of Use or Nonuse of Key Lock

Selection for key lock function to (in) activate setting keys on your DC100 or DR.

- Non-use : DC100 or DR keys can be used.
- Use : DC100 or DR keys will be inactive when pressed. Even if key lock is executed, the power switch, DISP/MODE key operation and cursor key operation remain effective. Some keys can be selected to be locked or free. Selectable keys are: the Start key, the Stop key, the Clock key, the FUNC key, the FD COPY key, and the M.FUNC key. Click Free to activate them, Lock to lock them.

Setting Password

After activating the keylock it is possible to (in) validate the keylock using the FUNC Key (depending on the settings in the FUNC menu). To use the FUNC option it is necessary to enter a password in the range of 0 to 9999.

Display Update Interval

Select the display update interval when the operation display mode is set to Auto. Select 2, 3, 4, or 5 seconds.

Indication for Display

Select whether to have Channel Number or Tag indication on the DC100/DR display. Note that the channel number will be printed/displayed regardless of selection, if no Tag setting is made (or all spaces).

4.29 System Configuration

- 1 Select Config. > System Configuration from the menubar to display the System Configuration setting screen (see below).

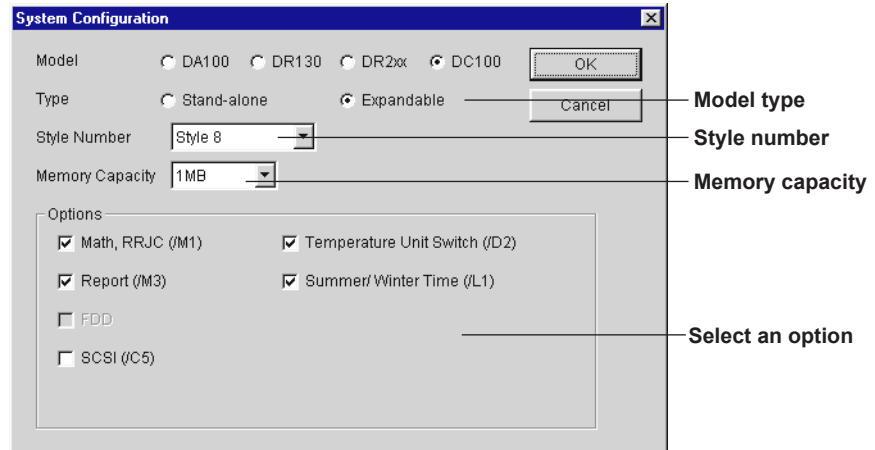

- 2 Depending on the device model you want to make settings for, select Model DA100, DR130, DR2xx (DR231/241/232/242), or DC100.
- 3 If relevant, select Type Standalone, or Expandable.
- 4 Select the appropriate Style Number using the pull-down menu. Make sure to set it as the setting screen contents also depend on the Style number.
- 5 If DC100 is selected in step (2), use the pull-down menu to select the appropriate Memory Capacity.
- 6 Select the Options related to the DA100/DR130/DR2xx/DC100 you use.
- 7 Click OK to initialize the above System Configuration settings.

Note

- During system configuration, all settings are initialized. Before connecting the hardware, check if Module Configuration matches the actual module construction.
- During system configuration, data files that are being edited, will be named 'newfile.' Please add a name before saving such a file.

4.30 Subunit and Module Configuration

It is possible to attach or remove units and modules, or to change module types using DARWIN Hardware configurator.

Select Config. > Module Configuration from the menubar to display the Module Configuration setting screen.

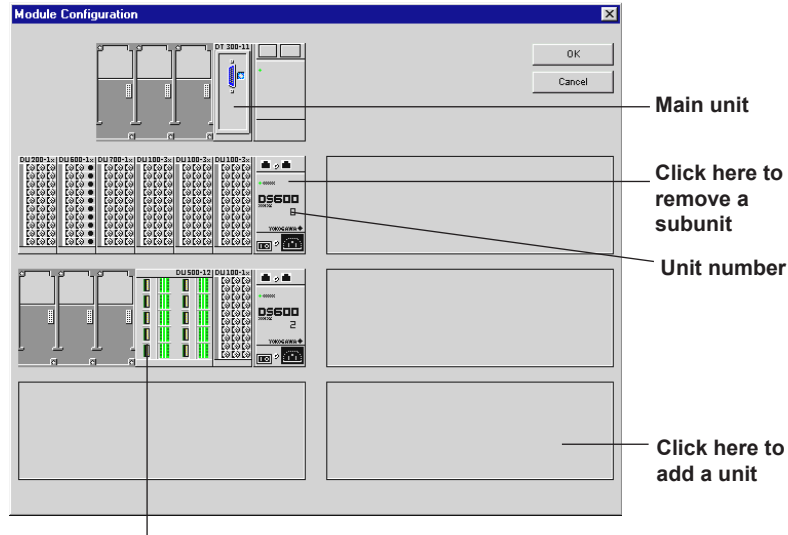

When pointing a module, its name will appear.

A module selection pull-down menu will appear when it is clicked.

Adding and removing subunits

To add a subunit click an empty subunit placing area and click OK when asked 'Add Unit?.'

To remove a unit click right side of the module (reading DS600/DS400) and click OK when asked 'Delete Unit?.'

Adding and Removing Modules

To add a module, click the module space on a subunit. The Module Selection pull-down box opens. Select the desired module, and click OK. The selected module will get displayed.

To remove a module, again click the module you want to remove, and in the Module Selection pull-down box that appears, select NONE.

Note

- If a unit or module gets removed, all the settings related to it, will also be reset.
- All subunits will be appear as DS660s. When adding modules, apply a maximum of 4 DS400 modules, or 6 DS600 modules.

4.31 Initializing Settings

It is necessary to initialize the edited settings as follows:

- 1 Select Settings > Initialize Settings from the menubar to display the Initialization dialog box (see below).



- 2 Select whether to set All Settings, or the SET (Regular) Settings Only.

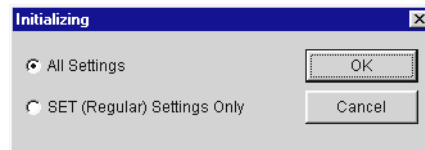

- 3 To start initializing click OK, and again OK when a reconfirmation message appears.

4.32 Sending Setting Data

Send the DARWIN Hardware configurator setting data to the DA100/DR/DC100 as follows.

- 1 Select from the menubar Comm. > Send > and then, All Settings, SET (Regular) Settings Only, or Modified CH/Math Settings.



Depending on which settings you want to send to the DARWIN hardware, and possibly to save a lot of sending time, select:

- All Settings.
 - SET (Regular) Settings Only.
 - Modified CH/Math Settings. This means sending all the settings actually modified on the Channels and Math setting screens only.
- 2 Sending will start after you click OK when the reconfirmation message is displayed.

Note

- Before connecting the hardware, check if Module Configuration matches the actual module construction.
- If a file remains in the internal RAM disk of the DC100, it is not possible to send settings to its internal RAM disk. Initialize the internal DC100 RAM disk before sending data to the DC100, or initialize the DC100 using this software. In that case, make sure to first copy important files.
- If files remain on the DC100 internal RAM disk, when sending data to the DC100 the writing action does not change automatically to SINGLE or REPEAT, when it was earlier set to NONE on the DC100, and likewise, not to NONE if it is set to SINGLE or REPEAT on the DC100.
- If files remain on the DC100 internal RAM disk, when sending data to the DC100, the periodic file type (see Section 4.18) does not change automatically to Meas or Report, when it was earlier set to NONE on the DC100, and likewise, not to NONE if it is set to Meas or Report on the DC100.
- If the following settings have been changed, only the channel data for the SET (regular) mode will be send.
 - System configuration, or module construction.
 - Initialization of edited data.
 - Re-configuration.
 - Initialization of DA100, DC100, DR.
 - Writing method of measurement data.
- Communication is not possible if the Logging monitor or record function is active.
- If data are send, during computation, reporting, or (for DC only) data writing, those actions will be canceled.
- If only altered settings are send event/action, Math, Report, or Memory Pause, LEVEL actions, will not be canceled.
- When using ether communication, error detection may take a few minutes.

4.33 Saving Setting Data

Save the DARWIN Hardware Configurator settings as follows:

- 1 Select File > Save, or Save As... from the menubar. You may also use the save icon

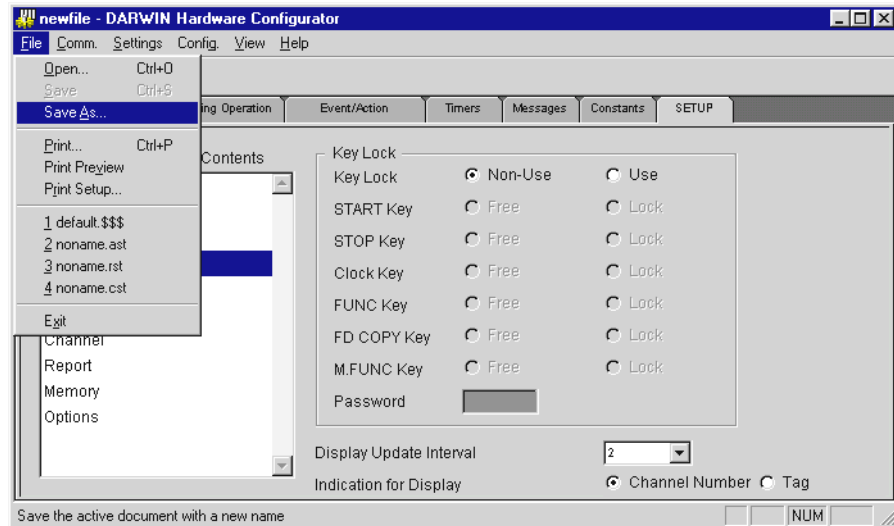

- 2 If you choose Save As... you will be requested to select where to save the file to, and to enter a File name and Comment. After this click the Save button.

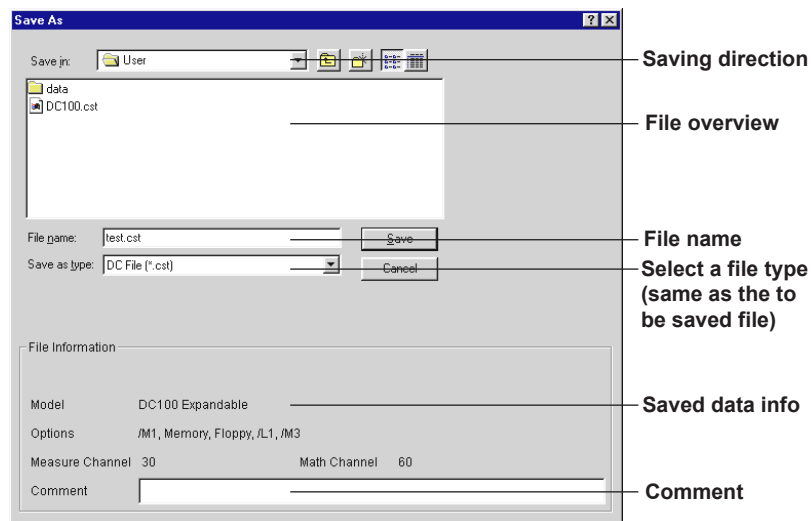

- Depending on the kind of data, the below extensions will automatically be added to file names.
 - .ast : for a DA100 settings data file.
 - .rst : for a DR settings data file.
 - .cst : for a DC100 settings data file.
 - .set : for a data file containing SET (Regular) Settings created with a DC100 or DR.
 - .pnl : for a data file containing SETUP (Basic) Settings created with a DC100 or DR.
- A Comment can only be set for DA 100 (.ast), DR (.rst), and DC100 (.cst) data files.

4.34 Hardware Configurator Display Settings

Displaying Tag No. and Tag Comment

DARWIN Hardware Configurator allows you to use Tag No. display or Tag Comment display instead of channel number display in the setting screen. To do this, select View > Tag No. or Tag Comment.

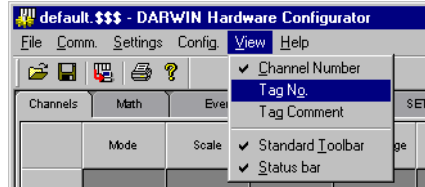

Displaying/hiding the Standard toolbar and Status bar

Choose to display or hide the Standard toolbar and Status bar (de)selecting the terms under View on the menubar.

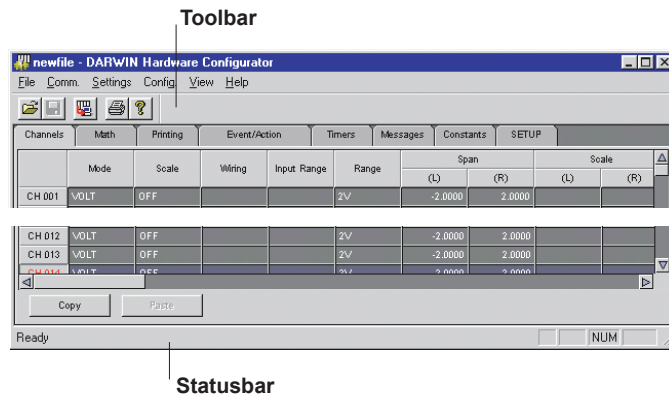

4.35 Printing Settings

- 1 To print all settings select File > Print... from the menubar.

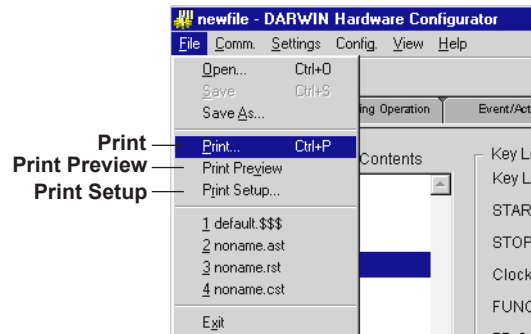

The Print setting screen will appear.

- 2 After finishing Printer, Print range, and Copy settings click OK to start printing.
 - To check the printout before printing select File > Print Preview from the menubar.
 - Select File > Print Setup for the standard Windows print settings.

4.36 Activating Hardware Actions

The following DA100, DC100, or DR hardware actions can be activated:

- System Restructuring.
- Initializing Hardware.
- Math: Start/Stop/Clear and Start/Clear.
- Report: Start/Stop.
- DC100 Writing Data Action: Start/Stop/Pause.
- Strain Balancing/Initialization/Object Input Channels. (Only for strain modules)

Math, Report, Writing and Strain actions can only be made if settings have first been received from a DA100, DC100, or DR. After receiving the data, you may not have changed the system, or module construction.

- 1 Select Comm. > Action > and choose the desired action.

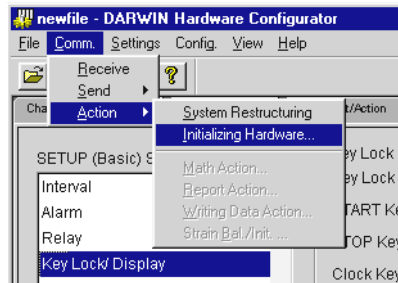

- 2 Read the follow-up instructions on the screen, to make detailed settings, and reconfirmation.

Note

- If one of the below five settings have been altered, the following actions cannot be activated: Math: Start/Stop/Clear and Start/Clear; Report: Start/Stop; DC100 Writing Data Action: Start/Stop/Pause; Strain Balancing/Initialization/Object Input Channels.
 - System configuration, or module construction.
 - Initialization of edited data.
 - Re-configuration.
 - Initialization of DA100, DC100, DR.
 - Writing method of measurement data.
- If the Logging monitor or record function is active following actions are impossible: Math: Start/Stop/Clear and Start/Clear, Report: Start/Stop, DC100 Writing Data Action: Start/Stop/Pause, the Strain Balancing/Initialization/Object Input Channels.
- If only altered settings are send event/action, Math, Report, or Memory Pause, LEVEL actions, will not be canceled.
- When using ether communication, error detection may take a few minutes.

5.1 Operating Logger Software

Starting Logger software

To start Logger, select a Project, and click the Logger button on the Launcher toolbar, or right-click the Launcher icon on the taskbar, and select Logger. The Project that appears has the same conditions as when it was closed for the last time.

If you have set Auto Startup for Monitoring and/or Recording in the Launcher Project Settings dialog box, the Monitor or Record functions will be activated automatically.

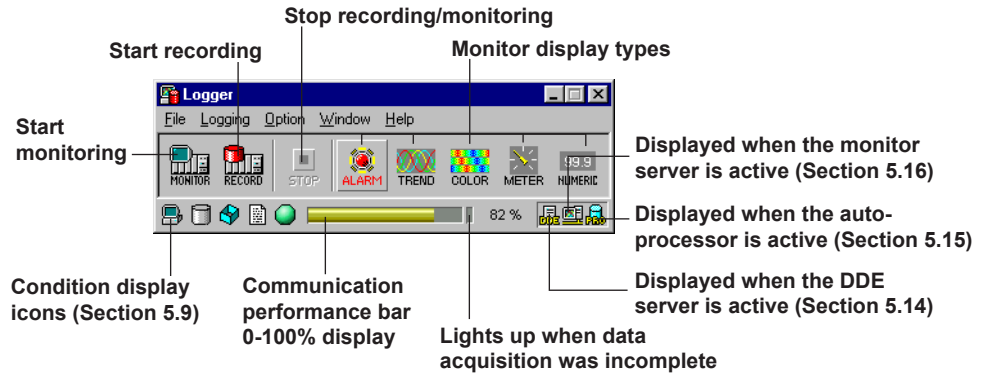

Displaying Measurement/Math Channel Data

Measurement or Math channel data can be displayed as waveforms on a Trend monitor, on a Meter monitor, or a Numerical monitor. From the available 30 groups you can display the data of one group at a time. A group can contain the data of maximum 32 channels. Select the desired group by clicking the group tab in the monitor screens.

5.2 Logging Configuration

Please set the following conditions before collecting measurement data:

- 1 Select from the Logger menubar Logging > Logging Configuration... to open the Logging Configuration setting screen.

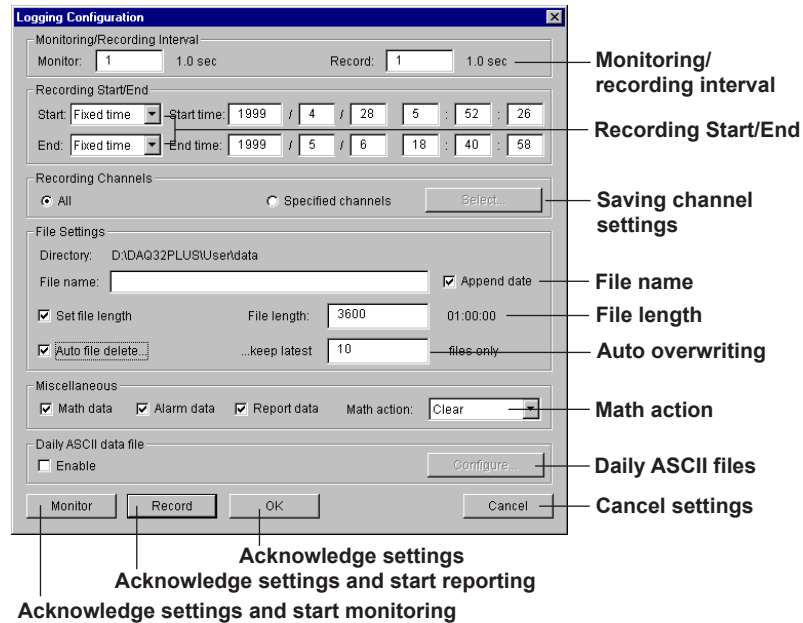

Monitoring/Recording Interval

- 2 Enter the interval for renewing the observation monitor in the Monitor setting box. The monitoring interval is the integer of the DA100/DC100/DR measurement interval.
- 3 Enter the recording interval for writing data to, for example, the harddisk of your PC, in the Record interval setting box. The recording interval is the integer of the monitoring interval.

The monitoring and recording intervals are displayed on the right side of the Monitor/Record interval setting boxes.

Recording Start/End

Set starting and ending conditions for writing measurement data to, for example, the harddisk of your PC.

- 4 Starting Time: Set the Start dialog box to On Record or Fixed time.
On Record, means recording will start on the moment you press the Record icon on the Logger toolbar, or when you select Logging > Record from the Logger menubar.
When selecting Fixed Time, set the automatic recording starting time.
- 5 Ending Time: Set the End dialog box to None, Data count or Fixed time.
None: Recording will start on the moment you press the Stop icon on the Logger toolbar, or when you select Logging > Stop from the Logger menubar.
Data count: Enter the exact datacount after which you want recording to hold.
When selecting Fixed Time, set the automatic recording ending time.

Miscellaneous settings

- 6 To collect, besides Measurement data, Math, Alarm or Report data check the Math data, Alarm data, or Report data checkboxes in the Miscellaneous dialog box.
- 7 If you selected Math data above, use the dialog box on the right to set the Math action to either Clear, Start, Stop, or Clear & Start.

Note

- For DA100, DC100, and DR with/M3 option report data can be collected if Report data is checked.
- Report data will be collected if a report file is created for DA100, DC100, or DR. Report names will be, for hourly reports (Hourly-YYYYMMDDHH.RBI), for daily report (Daily-YYYYMMDDHH.RBI), and for monthly reports (Monthly-YYYYMMDDHH.RBI). YYYY (year), MM Month, DD (day), and HH (hour), mark the time when the report was created.
- The report file is saved in the same directory as the measurement data file.
- If the time on your DARWIN instrument changes from summer to wintertime (resulting in one hour which is measured twice) a second daily report will not be created.

Saving Channel settings

- 8 To select the kind of recording channels you want to save, click either All or Specified Channels in the Recording Channel dialog box. If you want to save Specified Channels, click the Select button on the right, in the Channel setting screen that opens, select the channels you want to save, and click OK.

File and saving condition settings

- 9 In the File Settings dialog box enter a File name. If you check Append Date the complete file name will be: **File Name - Date - Follow-up number .DAQ** (.DAQ being the extension). For example; AAA-19981228-0001.DAQ.
- 10 If you want to limit the length of files, check the Set File Length box, and the File Length. Only the entered data amount will get saved.
- 11 If you wish to overwrite files starting with those saved last, check Auto file delete... , and enter which files should be kept.

5.2 Logging Configuration

Daily ASCII data files

Hourly data are collected to make Daily ASCII data files.

- 12 When making a Daily ASCII data file, check Enable and then click the Configure button. The Daily ASCII data file setting screen will appear.

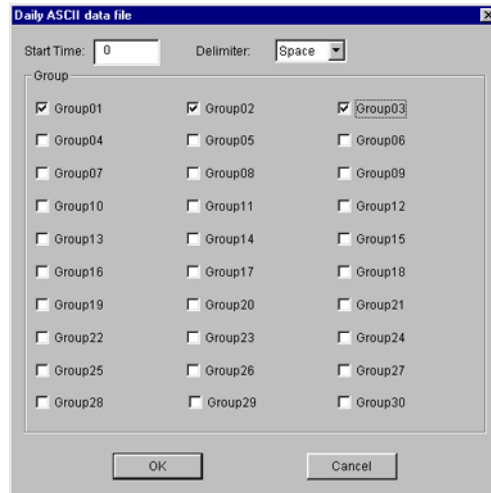

- 13 Select the Start time you want to be saved to the file between 0 and 23.
- 14 Select a Space or a Comma as delimiter.
- 15 Check the Groups to which you want to save the Start time as Daily file.
- 16 Click OK to return to the Logging Configuration setting screen.

Note

If the monitoring interval exceeds 1 hour, the automatic Daily file setting will be inactive.

Applying the Setting conditions

- 17 Click the OK button to activate the above settings without starting data collection. Click Monitor to acknowledge the settings and immediately start monitoring. Click Record to acknowledge the settings and immediately start recording.

5.3 Group Settings

- 1 Select Logging > General Display Settings... to open the General Display Settings dialog box. The dialog box can also be opened from each monitor screen by selecting View > General Display Settings.

The screenshot shows the 'General Display Settings' dialog box. It features a table with columns for No., Channel, Y-Axis, Meter Type, Scale (Min, Max), Zone (Min, Max), Trip 1, Trip 2, and Color. The table lists channels W01 through W14. Annotations point to various UI elements: 'Setting Y-axis display ON/OFF' points to the Y-Axis column; 'Recording channel' points to the Channel column; 'Display ON/OFF' points to the checkboxes in the No. column; 'Linear/Log' points to the Y-Axis dropdown; 'Bargraph' points to the Meter Type dropdown; 'Meter display' points to the Meter Type icons; 'Thermometer' points to the Meter Type icons; 'Setting trip point display ON/OFF' points to the Trip 1 and Trip 2 columns; 'Group Name' points to the Group Name field; 'Display scale' points to the Scale columns; 'Display zone' points to the Zone columns; 'Group tabs' points to the tabs at the top; 'Trip settings' points to the Trip 1 and Trip 2 columns; 'Color display' points to the Color column; 'Set all trip points ON/OFF' points to the Trip 1 and Trip 2 columns; 'Set to initial values*' points to the Trip 1 and Trip 2 columns; 'Waveforms all ON/OFF' points to the checkboxes in the No. column; 'Select same meter for all waveforms' points to the Meter Type column; 'Set to initial values*' points to the Trip 1 and Trip 2 columns; 'Copy' points to the Copy button; 'Paste' points to the Paste button; 'Select copy items' points to the Copy button; 'Set same zone as first zone for all' points to the Zone columns.

Channel numbers appear in order from W01

Set same zone as first zone for all

* Channels to be set to initial values can be selected by dragging number's column.

- 2 Click the tab of the group you want to open.
- 3 Enter a group name with up to 16 characters in the group name textbox.
- 4 Select the channel you wish to record in the group. Select a channel number and an overview of the channel numbers will appear. The channel you select here will be recorded. If you wish to record channel display with a tag or tagID instead of a number, make the changes on the monitor screen.
- 5 Click the boxes in front of the waveform numbers on the left, to select which data you want to be displayed.
- 6 If Multi-Axis Zone is selected for the trend monitor, you can select whether or not to display the Y-axis. You can also choose between Linear, and Log Y-axis display. Click the square on the left of the Y-axis setting box to display (blue color), or hide the Y-axis. If you want to display the Y-axis, additionally click linear or log.
- 7 Select the Meter type: a bargraph meter (left), 'speedometer' (middle), or thermometer (right).
- 8 Set the maximum and minimum Scale.

Note

The input range is between -999999 and 999999, excluding decimal points. Additional decimal points will automatically be round off depending on the measured data and scale.

- 9 Set the waveform display area (Zone).

Note

- If the highest and lowest scale values are the same, then the highest setting will automatically be increased with 1, and the lowest setting value will be decreased with 1.
- The lowest setting range for the Zone is 0 to 99%, the highest is 1 to 100%.
- In the waveform monitor display area, the lowest value is 0%, the highest value is 100%.

Trip points

A trip point sets the position of a horizontal line on a waveform display you can use to highlight specific values. You can set two different trip points. Trip point 1 is displayed in red, trip point 2 in blue.

- 10 Set Trip point 1 and Trip point 2 to ON (blue) or OFF for each channel.
- 11 Enter the appropriate Trip point 1 and Trip point 2 value.

Note

- The trip points actually displayed in the waveform display area are the trip points for the active waveform.
- The Trip value must be within the Scale value set for each channel.
- You can change the position of the horizontal 'trip' lines by dragging the trip point labels on the right side of the waveform display area with the mouse.
- Display will be set ON, when you set a Trip point. Click the Trip checkbox if you don't want the Trip to be displayed.

- 12 Click in the color channel of each channel to display the Color setting box. Select the desired color and click OK.

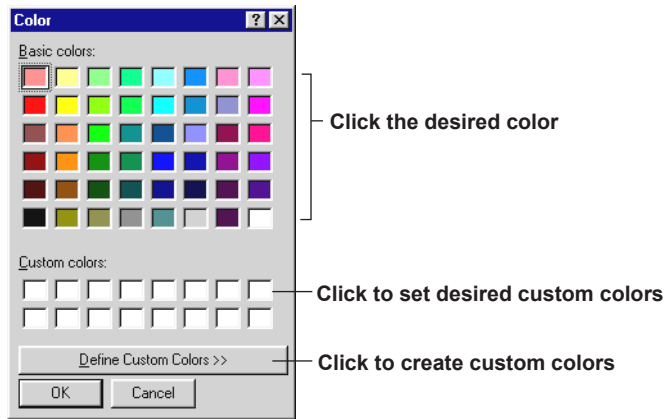

To make your own colors, click Define Custom Colors >>. The dialog box below for setting custom colors appears. Set the desired hue, brilliance and brightness. After setting the custom color, click Add to Custom Colors. Click OK to save the colors.

- 13 To apply click OK (the General Display Settings dialog box will disappear), or Apply, if you wish to keep the General Display Settings dialog box open.

Copy the Settings

To copy settings made for one channel to other channels, do as follows:

- 3 Click Copy Setting, to display the Copy Setting dialog box.

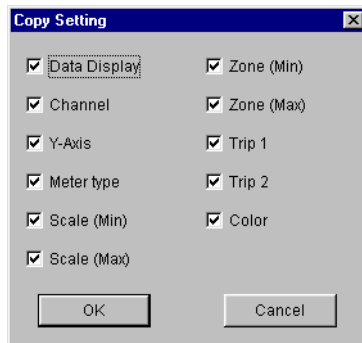

- 4 Click the desired copy items and click OK.
- 5 Click the copy base channel. The display color will change.
- 6 Click the Copy button.

- 7 Click the channel numbers you want to copy the base settings to. The display color will change. Drag the mouse point down from the first to the last channel, if you wish to copy to a successive series of channels.
- 8 To copy the base channel to the selected channels, click the Paste button.

Setting the same amount of channels for each Group automatically

There are 2 methods to set the same amount of channels for each Group automatically:

- Put all active channels from the DA100/DC100/DR in successive groups.
- Using the groups created in the above explained way, make successive regroupings.

For example an automatic regrouping per three channels looks as follows:

Before setting			After Setting		
Group 1	W01	CH001	Group 1	W01	CH001
	W02	CH002		W02	CH002
				W03	CH005
Group 2	W01	CH005	Group 2	W01	CH006
	W02	CH006		W02	CH007
	W03	CH007		W03	CH008
	W04	CH008			
	W05	CH009			
Group 2	W01	CHA01	Group 3	W01	CH009
	W02	CHA02		W02	CHA01
	W03	CHA03	W03	CHA02	
	W04	CHA04	Group 2	W01	CHA03
		W02		CHA005	

- 1 Select Logging > Auto Grouping... to open the Automatic Group Setting dialog box.

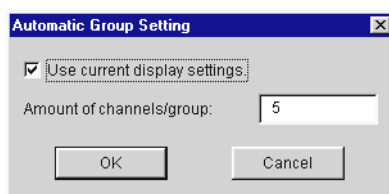

- 2 Select whether you wish to group current display settings or not.
- 3 Enter the amount of channels you desire per group.
- 4 Click OK to start automatic grouping. In case the General Display Settings dialog box is still open while you make above settings, you will have to close and reopen it once to apply the changes.

5.4 Displaying Waveforms on the Monitor

Logger software allows you to display measurement data on a Trend Monitor, Color Monitor, Numeric Monitor, Meter Monitor, and Alarm Monitor.

- 1 To open monitors, push the Trend, Color, Numeric, Meter, or Alarm icon in the Logger toolbox or select Logging > , and the appropriate monitor from the menubar.
- 2 To start actual monitoring, click the Monitor icon in the Logger toolbox or select Logging > Monitor. Measurement values will start to get displayed on all display monitors.

Note

- Select how to display more than one display monitor on your screen by selecting Window > and Cascade, or Tile, from the Logger menubar.
- If the whole screen is filled with monitors, hiding the Logger Toolbar, you can let it appear again by clicking the Logger icon above each monitor screen, or by selecting Window > Logger from the monitors menubar.
- Without starting monitoring, no measurement values will get displayed even when you open the monitor screens.
- If monitoring is started, but no monitors are opened, data acquiring commences. The data will all be displayed, as soon as you open a monitor.
- It is possible to open several monitors at the same time, but it may slow down performance.

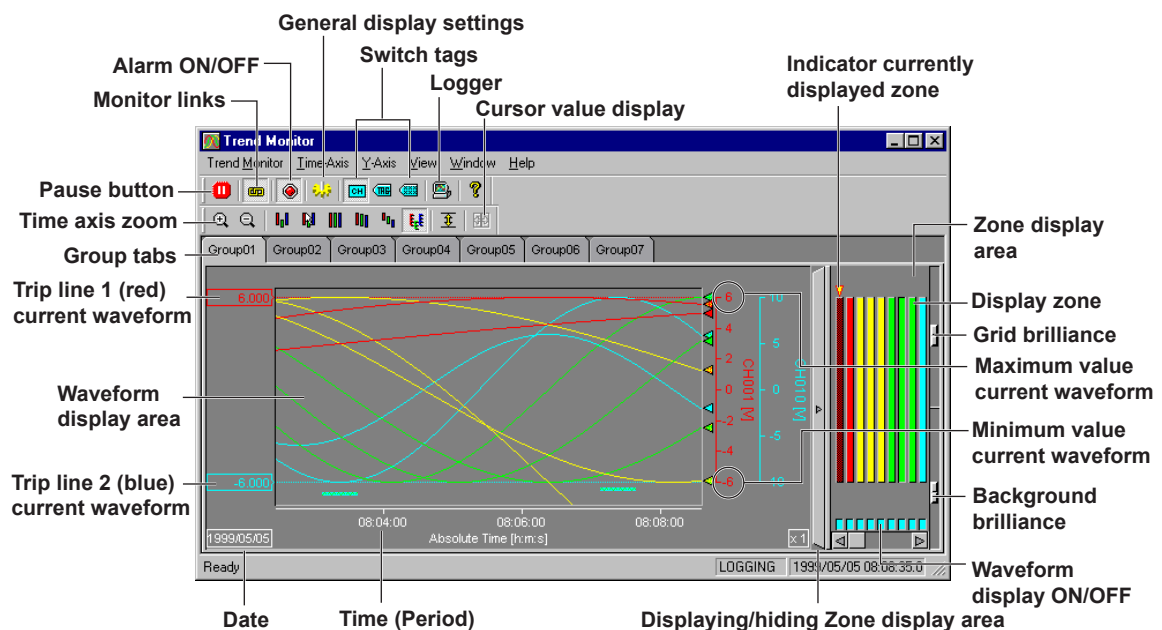

Color display

Linking channels Display logger Channel/Tag/Tag ID

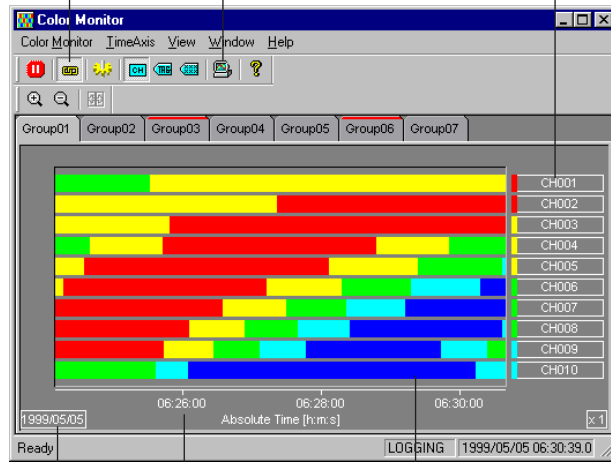

Time/time period
 Date Min. and max. values are parted with 50 colors, from blue (min.) > green > yellow, to > red (max)

Meter display

Alarm ON/OFF

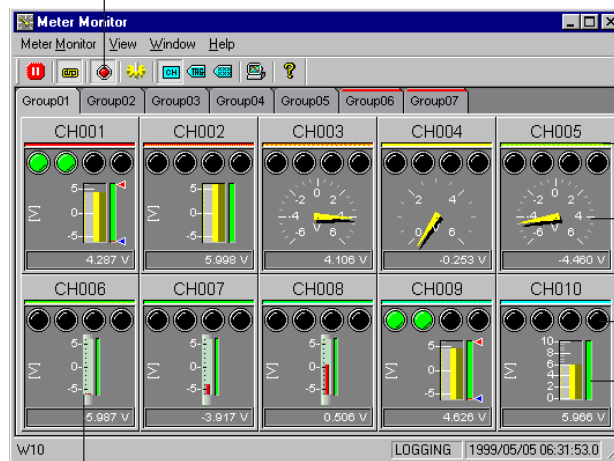

Waveform display color
 Analog meter
 Alarms
 Barmeter

Thermometer

5.4 Displaying Waveforms on the Monitor

Digital value display

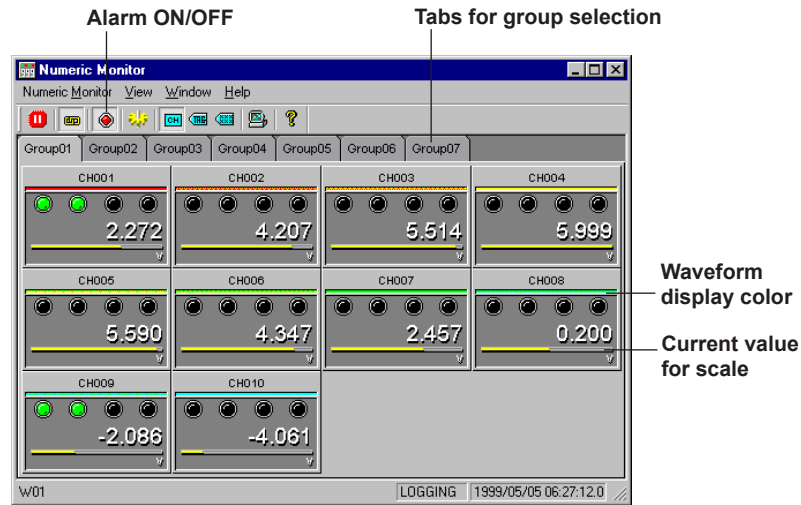

Alarm display

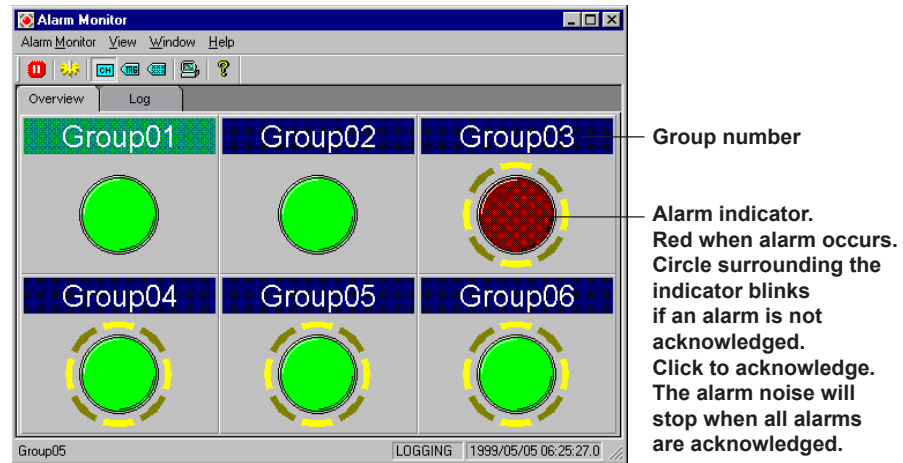

Displaying groups.

To change the group on display, click the appropriate group tab above the monitoring screen.

Alarm display

Alarms will be displayed both in the lower section of the Trend monitor display area. If there is an alarm going off in any other group, its tab will light up red.

Setting alarm noise ON/OFF

For alarm noise to indicate whether an alarm occurs, select Alarm Monitor > Alarm Sound on the Alarm Monitor. To set the alarm OFF either click all the alarm groups, or select View > Alarm Hold Reset.

Note

Your PC must have a sound source, to hear the alarm noise.

5.5 Stopping or Pausing Monitor display

Pausing monitor display

When monitoring is paused, data acquisition continues. When restarting the display, data acquired during the pause will be displayed.

- 1 To pause, click the red Pause button above each monitor.

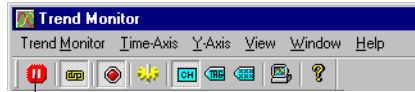

Pause button

- 2 To resume monitoring, click the Pause button again.

Closing monitor display

When a monitor is closed, data acquisition continues. When reopening the display, data acquired during the pause will be displayed.

To close a monitor click from the menubar 'x' Monitor > Exit

Stopping monitor display

When monitoring is stopped, data acquisition also stops, and no more data will be displayed.

- 1 To stop monitoring click the Stop button on the Logger toolbar.

Monitor/Record stop button

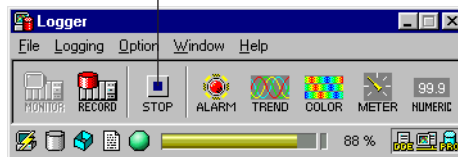

If monitoring and recording are active simultaneously, clicking the Stop button will first result in stopping the Record function. Click Stop again to stop the Monitor.

5.6 Changing Monitor Display

General Display Settings

- 1 Click the General Display Settings button on the Monitor toolbar, or select View > General Display Settings, to open the General Display Settings dialog box.

See Section 5.3, "Group Settings for details."

Changing the Time Axis of the waveform display

To change the Time Axis of the waveform display, select TimeAxis > and Absolute Time, or Relative Time from the Trend monitor menubar.

- Absolute time shows the actual time during display.
- Relative time shows the time lag from the first displayed data.

The time axis scale, and grid division will change automatically, depending on the displayed time range.

Enlarging or reducing the Time Axis scale

To change the Time Axis scale, use the Zoom In or Zoom Out buttons, or select TimeAxis > and Zoom In or Zoom Out, .

Zooming will change display in the order: 1/20x, 1/10x, 1/5x, 1/2x, x1, 2x, 5x, 10x, 20x.

The most detailed possible display may however vary depending on the pixel amount in the display area.

Selecting the waveform display zone

Use the below zone buttons on the monitor toolbar, or select Y-Axis > and the desired zone.

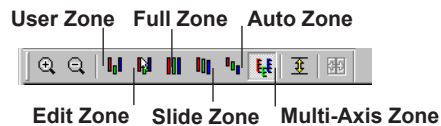

Select the Edit Zone, User Zone, Full Zone, Slide Zone, Auto Zone, or Multi-Axis Zone.

- Edit Zone

If the Edit Zone is selected, it is possible to change zones simply by pulling the channel zone display, on the right of the window on right side of the waveform display window up (Zone top adjustment) and down (Zone bottom adjustment). The zone settings will be reflected in the General Display Settings dialog box.

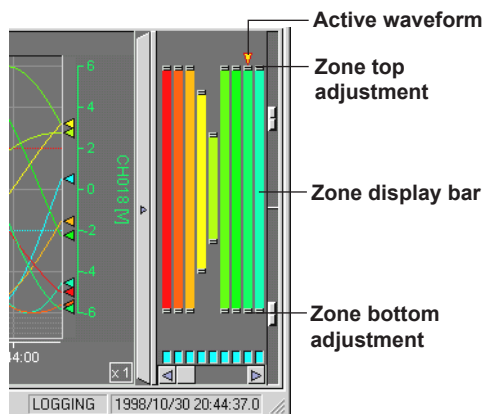

- User Zone
The User Zone shows Edit Zone settings, but these zone settings can not be changed.
- Full Zone
Use the Full Zone to display all waveforms in a 100% zone range.



- Slide Zone
In Slide zone all waveforms scales are shifted slightly from top to bottom.

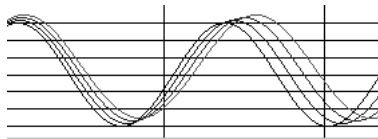

- Auto Zone
In Auto Zone the Y-axis of the waveform display area is divided into equal parts for each selected waveform.

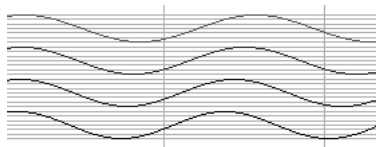

- Multi-Axis Zone
Displaying multiple Y-axis.
Select an axis for display as follows:
 - Use the General Display Settings (See section 5.3, "Group Settings").
 - If display in the Trend Monitor screen is being paused, you can drag and drop Zone display bars, to and from the Y-axis display area in the Trend Monitor screen.

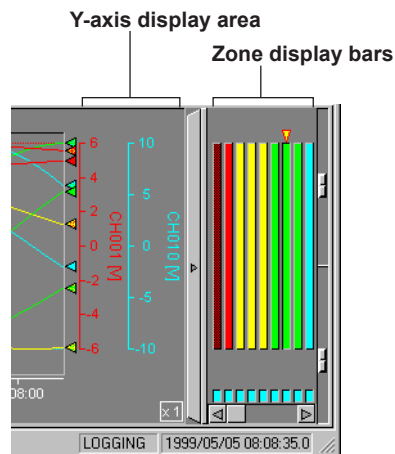

5.6 Changing Monitor Display

Setting the Y-Axis display limiting Clip

It's possible to apply a display limit Clip to waveforms you view. When you set the display limit function, waveforms will be limited between the minimum and maximum values on the Y-Axis scale. Waveforms with data points smaller than the minimum scale value or larger than the maximum scale value will be truncated. This function enables you to view waveforms outside the screen range as horizontal lines in the display area. Click the Clip button (below) from the monitor toolbar, or select Y-Axis > Clip.



- Waveform without Clip :



- Waveform with Clip :



Linking other monitors

If you Link the monitor display with other monitor displays, settings for one display will get copied to all other displays. To do so, click the Link button from the monitor toolbar, or select Trend Monitor > Monitor Link.



Selecting Channel, Tag No. or Tag Comment labeling

Click the Channel, Tag No. or Tag Comment button from the monitor toolbar, or select View > and select either Channel, Tag No. or Tag Comment.

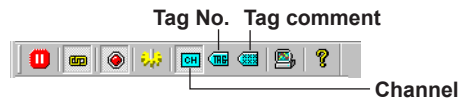

Setting waveform display ON/OFF inside the display area

Click the channel buttons on the bottom of the Zone display area on right side of the waveform display window.

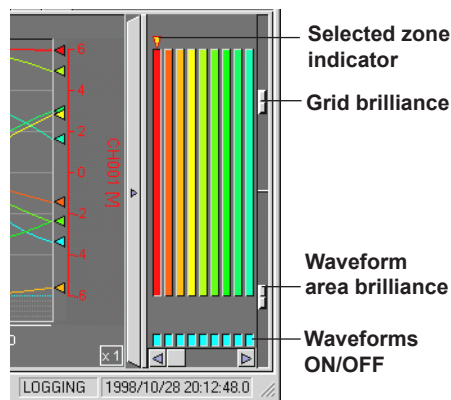

Adjusting display grid and background brilliance

Move the buttons on the right of the Zone display area on right side of the waveform display window up and down to adjust display grid and background colors.

Alarm Settings

Alarm display in the Trend, Numeric, and Meter monitor

Click the Alarm button (below) from the monitor toolbar, or select View > Alarm.

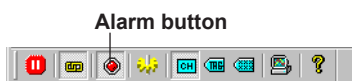

Alarm monitor display

The Alarm Monitor displays an Overview and a Log screen. The screens can be interchanged by clicking the Overview or Log tabs on the Alarm Monitor.

- Alarm overview
 - Alarm conditions within a group are displayed in the following 4 ways:
 - Green lamp: No alarm occurrence.
 - Red lamp: Alarm occurs.
 - Green lamp + surrounding circle blinking: No alarm occurrence, but a past alarm has not yet been acknowledged.
 - Red lamp + surrounding circle blinking: Alarm occurs. Additionally, a past alarm has not yet been acknowledged.
- Alarm log data
 - In the alarm log screen are listed: Types of earlier occurred alarms, alarm occurrence/release times, and alarm channels.

Alarm condition	Alarm type	Alarm occurrence/release time				Channel with alarm
		Date	Time	Channel	Status	
	↑	1998/10/16	21:07:56.0	CHA17 L1	H	On
	↓	1998/10/16	21:08:00.0	CH033 L2	L	Off
	↑	1998/10/16	21:08:01.0	CHA17 L1	H	Off
	↑	1998/10/16	21:08:08.0	CHA25 L1	H	On
	↓	1998/10/16	21:08:11.0	CHA01 L2	L	On
	↑	1998/10/16	21:08:13.0	CHA25 L1	H	Off
	↓	1998/10/16	21:08:18.0	CHA01 L2	L	Off
	↑	1998/10/16	21:08:22.0	CH017 L1	H	On
	↓	1998/10/16	21:08:25.0	CHA09 L2	L	On
	↓	1998/10/16	21:08:30.0	CHA09 L2	L	Off

Alarm Types are marked with the following symbols:

<p>high limit alarm</p>	<p>low limit alarm</p>	<p>difference upper limit alarm (red)</p>
<p>difference lower limit alarm (blue)</p>	<p>low limit on rate-of-change alarm</p>	<p>high limit on rate-of-change alarm</p>

Acknowledging Alarms

An alarm on the Alarm monitor surrounded by a blinking circle, is not yet acknowledged. To acknowledge the alarm, click its channel button. To set the alarm noise OFF all the alarm groups must be clicked.

5.7 Cursor Measurement

It is possible to read time and measurement data values on the X-Axis using two cursors: cursor A and cursor B. This may be useful if you want to know the time or voltage difference between two occurrences. Use the cursors as follows:

- 1 During monitoring cursors are not displayed. Therefore, before setting any cursors, click the red Pause button.

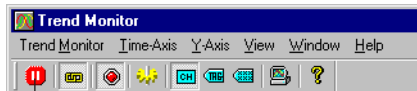

Pause button

- 2 Point the mouse at the position in the waveform display area where you want to read measurement data. The vertical bar that appears first is cursor A. Hold the mouse and drag the pointer to the next position where you want to read measurement data. Cursor B gets set when you release the mouse.

Example of cursor display:

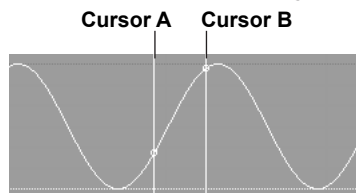

- 3 Select Window > Display Cursor's Value, or click the Cursor Value button on the toolbar.

In the Cursor's Value dialog box you can now read measurement values at the cursor positions and the value difference between the two cursors positions.

If you wish to accurately adjust the position of a cursor, click the arrow buttons next to data No. values in the Cursor Value dialog box. The cursor will move one steps per data item.

	Cursor A	Cursor B	Difference
Data Number	14:	31:	176
Absolute Time	1998/10/30 20:36:39.0	1998/10/30 20:39:35.0	00:02:56.0
Channel	Value A	Value B	Value B-A
VW01:CH011[V]	2.063	-3.798	-5.861
VW02:CH012[V]	0.584	-1.055	-1.639
VW03:CH013[V]	-0.933	1.956	2.889
VW04:CH014[V]	-2.390	4.471	6.861
VW05:CH015[V]	-3.695	5.854	9.549
VW06:CH016[V]	-4.763	5.753	10.516
VW07:CH017[V]	-5.526	4.194	9.720
VW08:CH018[V]	-5.935	1.572	7.507

Cursor control moving

Alarm display

- 4 To erase cursors from the waveform display area, select View > Hide Cursor. After doing this, no values will remain in the Cursor Value dialog box.

Note

- When you move a cursor in the Trend Monitor using your mouse while the Cursor Value window is still open, values in the Cursor Display window will also change.
- To move only cursor A in the display screen, press the Control button, and click on the position where you want the A cursor to appear.
- To move only cursor B in the display screen, press the Shift button, and click on the position where you want the B cursor to appear.

5.8 Starting and Stopping Recording

To write Channel measurement and Math data to the harddisk of a PC, first finish the communication settings as described in Section 3.4, “Selecting a Directory to Save Data.”

Start Recording

After that, click the Record button, or select Logging > Record from the Logger menubar.

Record start button

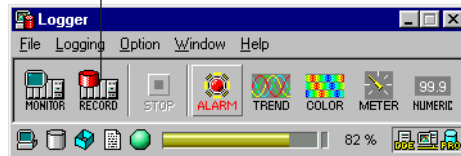

Stop Recording

Click the Stop button, or select Logging > Stop from the Logger menubar.

If monitoring and recording are active simultaneously, clicking the Stop button will first result in stopping the Record function. Click Stop again to stop monitoring.

Record stop button

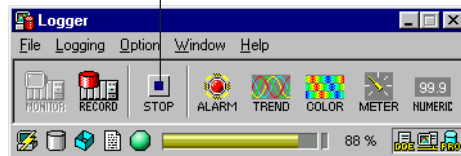

Data will be Recorded according to the conditions set in Section 5.2, “Logging Configuration, Recording Start/End.” If a fixed time was set, the Record button will be inactive.

When starting recording, a communication performance bar will get displayed. If some data from the DA100, DC100, or DR, aren't acquired properly, then this will be visible on the performance bar, as the indicator will start blinking. The communication indicator will keep blinking after the Performance bar exceeds 100%.

In such a case respond as follows.

- Increase the communication speed.
- Increase the length of the recording interval.
- Stop collecting Alarm data.
- Stop collecting Math data.
- Reduce the amount of modules attached to the DARWIN equipment.
- Use a faster communication module (RS-232-C/RS-422-A < GP-IB < Ethernet).

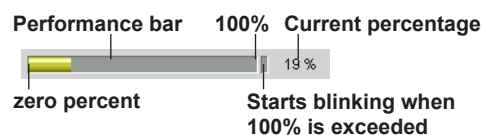

5.9 Icon Display during Monitoring/Recording

During Monitoring/Recording the following icons may be activated:

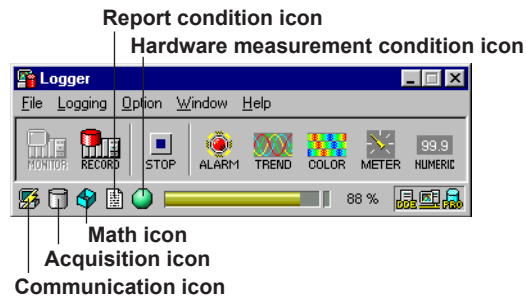

'Communication' icon

Plain icon : Communication stop.
Icon with thunder mark : Communicating.
Icon with exclamation ! mark : Communication error. Check cables and power supply.

'Acquisition' icon

Gray icon : Acquisition stop.
Red blinking icon : Acquiring data.
Red stable icon : Acquisition stand by.
Icon with exclamation ! mark : Disk error. Saving space may be insufficient.

'Math' icon

Gray icon : Not making calculations.
Icon with an X-mark on it : No Math option available.
Blue blinking icon : Calculating.
Blue stable icon : Stopping Math.
Icon with exclamation ! mark : Math error. Hardware Math may not be processed in time.

'Hardware measurement condition' icon

Blue icon: Normal measurement.
Red icon: Hardware measurement omission occurring.

'Report condition' icons

Grey icon : Not making report
An x above an icon : No report option available
Moving icon : Making report
Stable icon : Stopping report

5.10 Saving and Loading Setting Data

Saving Files

- 1 Select File > Save, or Save As... from the menubar. If you choose Save As... you will be requested to select where to save the file to, and to enter a File name and Comment. Setting data includes all Logger setting information. (Including display/logging condition, display window and position. Not including the status bar condition and toolbar positioning.)

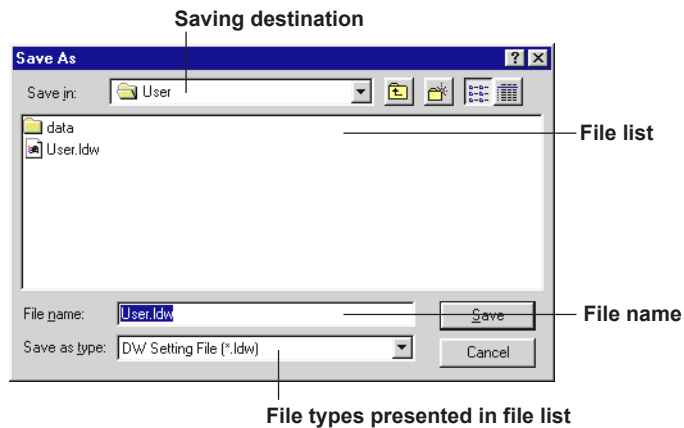

- 2 After selecting a destination click the Save button. The extension .ldw will automatically be added to the file name.

Loading Files

- 1 To open an previously created file, select File > Open. A File selection window opens.

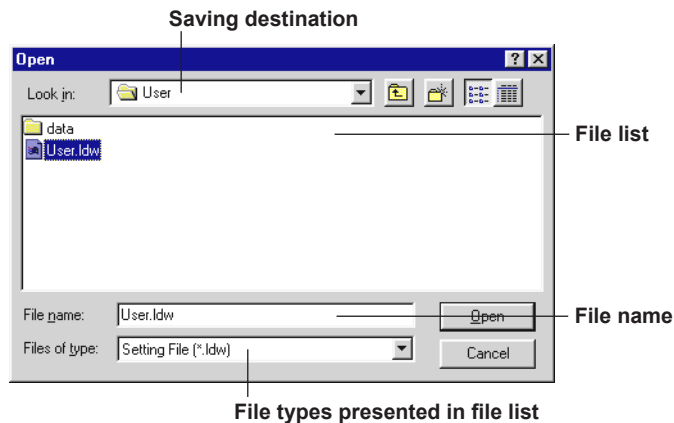

- 2 Select the desired File, and click Open. Measurement data that are being edited when a new file is opened will be overwritten.

5.11 Setting Math Actions, Resetting Alarms, and Starting/Stopping Reports

Setting Math Actions

To Start, Stop, Clear & Start, or Clear Math actions on Measurement data, select Option >, and the desired Math action from the Logger menubar.

Resetting Alarms

To Reset Alarms select Option > Reset Alarm, from the Logger menubar.

Starting/stopping reports

To start or stop the DA100/DC100/DR report function select Option, and Report Start, or Report Stop.

Note

If you start data logging using the Logger dialog box, the report function of the DA100/DC100/DR will be activated automatically if not yet active.

5.12 Reloading DARWIN Hardware Settings

Always when you change DARWIN hardware settings using DARWIN Hardware Configurator software, make sure to load the new hardware setting data to Logger. To load the hardware setting data, open the Logger dialog box and select Option > Reload Hardware Setting.

5.13 Checking Logging Status, and Printing Waveforms

Checking Logging Status

To check the logging status, select Logging > Current Logging Status.

Print Setup

- 1 Select Trend Monitor > Print Setup... and make the Printer settings. Click OK.

Print Settings

- 1 Select Trend Monitor > Print Settings... to choose Black & White, or Color printing, and to optionally enter a Comment in the textbox.

Start Printing

- 1 To print waveforms, first make sure monitoring is being paused. Then select Trend Monitor > Print. The Print Setting dialog box opens. Make Printer and Print Range settings, and set the amount of copies.
- 2 Click OK to start actual printing.

5.14 Using the DDE Server

Using the DDE server it is possible to display measurement data acquired with Logger, on a Windows application supporting DDE, like Excel.

- 1 To start using the DDE server, first select Option > Run DDE Server from the Logger menubar. The below DDE server dialog box opens.

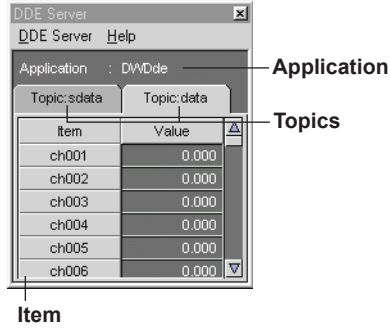

- 2 Open a Windows application supporting DDE

The following data can be displayed DDE supporting software, using a DDE server:

- Measurement data (Channel 001 to 560)
- Math Data (Channel 01 to 60)
- Date and Time
- Data number

For Excel, enter '=application!topic!item' in a cell. For example, to display the measurement data of channel 1, enter '=DWDde!data!ch001.'

Please, refer to your Excel manual, for details on the application of the data.

You can use the DDE server if the DDE icon is displayed in the Logger dialog box. Clicking the DDE icon will bring the DDE server dialog box to the front of your screen.

5.15 Using the Auto Processor

The following Auto Processor functions can be used.

- Automatic conversion function for measurement data files.
To instantly create an Excel/ASCII/Lotus 1-2-3 format after measurement data files are created with Logger software.
- Auto-printing function for report files.
To print report files after report data have been collected.
- Automatic conversion function for report files.
To instantly create an Excel/ASCII/Lotus 1-2-3 format after report files are created with Logger software.

Note

Report files are files created with a DA100/DC100/DR, and collected with Logger software. To create report files it is required to select Logging > Logging Configuration, and check Report data in the Miscellaneous frame. (See Section 5.2, "Logging Configuration")

Operating Procedure

- 1 Select Option > Run Auto Processor from the Logger window to open the Auto Processor window. If the Auto Processor window is opened, the Auto Processor icon will appear in the Logger window (see below).

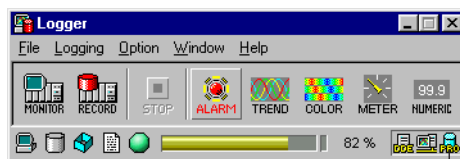

Auto-Processor icon

Automatic conversion for measurement data files

- 2 Click the DAQ tab.
- 3 Select the required format(s) for Automatic conversion.

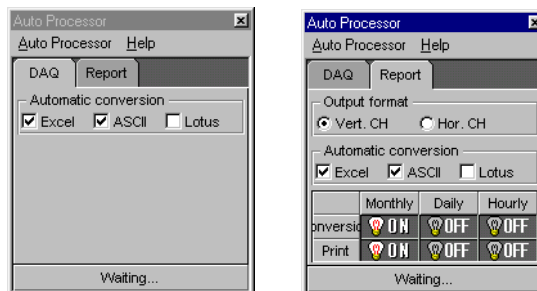

Auto-printing or automatic conversion of report files

- 4 Click the Report tab.
- 5 Select Vert. CH or Hor. CH from the Output format frame.
- 6 In the Automatic conversion frame select the required file format.
- 7 Click ON or OFF to respectively activate or deactivate conversion or printing of monthly, daily or hourly reports.

Printer settings

- 8 Select Auto Processor > Print Setup... to open the dialog box for printer settings.

- 9 If necessary make Printer, Paper, and Orientation settings, and click OK.

Note

Make sure that printer settings match the system environment of your printer.

Quitting the Auto Processor

Select Auto Processor > Exit. (If the Auto Processor window is not being displayed, click the Auto Processor icon (PRO) on the Logger window to make it appear.)

Note

For data conversion, please note the following points.

- Multiple data formats can be elected for conversion.
- The file extension of the converted file is automatically changed to the following format names, to distinguish it from the original file: Excel conversions (possible for version 4.0 or higher) get the extension "xls", ASCII files "txt", and Lotus (possible for version 2.0 or higher) files get the extension "wj2."
- A follow-up number will automatically be added to filenames if a file with an already existing name is being saved. For example:
Original file name_0000. Extension
(0000 being the follow-up number)
- For Lotus 1-2-3 and Excel there is a limit to the data that can be read. When the memory of your PC is not sufficient, data may not be read even though the data limit is not exceeded.
- The files with converted formats are saved to the same directory as the original.
- Do not select external media like floppy disk to save data. Access time will be longer, and some measurement data may not be saved correctly.
- Do not select save data in a root directory.
- Make sure there is enough memory before saving data.

5.16 Using the Monitor Server

The Monitor Server supplies PCs (remote monitors) connected to a network with measurement data.

See Chapter 9, "Remote Monitor Software."

Operating Procedure

- 1 Select Option > Run Monitor Server,

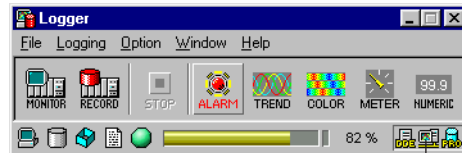

Monitor Server icon

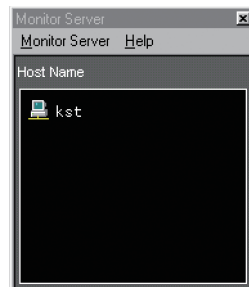

Client name

Communication port settings

- 2 Select Monitor Server > Port No... to open the port number dialogbox.

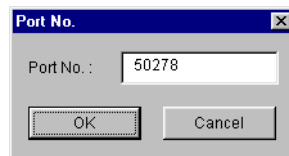

- 3 Enter the port number in the dialogbox and click OK.

Note

- The initial Port No. value is 50278. To change it select a number from 0 to 65535.
- The Port No. set for the Remote Monitor must match the Port No. set for the Monitor Server.

Pausing data renewal

To stop data at the Remote Monitor from being renewed select from the Monitor Server menubar, Monitor Server > Pause.

Quitting the Monitor Server

Select Monitor Server > Exit from the menubar. (If the Monitor Server window is not being displayed, click the Monitor Server icon on the Logger window to make it appear.)

6.1 Introducing Historical Viewer Software

Start Historical Viewer software

DAQ 32 Plus

- Select a project, and click the Historical Viewer button on the Launcher toolbar, or right-click the Launcher icon on the taskbar, and select Historical Viewer.
- From the Windows Start menu select Program > YOKOGAWA DAQWORX > DAQ 32 Plus > Historical Viewer.

DAQ 32 Plus Client Package

- From the Windows Start menu select Program > YOKOGAWA DAQWORX > DAQ 32 Plus > Historical Viewer.

Note

When Historical Viewer is opened using the Launcher, it is possible to display data that are being recorded with Logger software. You can not view data as they are being recorded with Logger if Historical Viewer is opened with the Windows Start menu.

From the available 30 groups you can display the data of one group at a time. A group can contain the data of maximum 32 channels.

Select the desired group by clicking the group tab in the monitor screens.

The following data can be viewed:

- Measurement, and Math channel data.
- Alarms.
- Measurement, and Math channel data between cursors.
- Statistical calculations between cursors.
- Report data (For details see Section 6.18 Displaying, “Converting, and Printing Report Data.”)

Furthermore, as for Logger, you can enlarge/reduce the Time Axis, use the Clip (waveform limiter) option, set zones, and display trip points.

Use the following display screen;

Waveform display

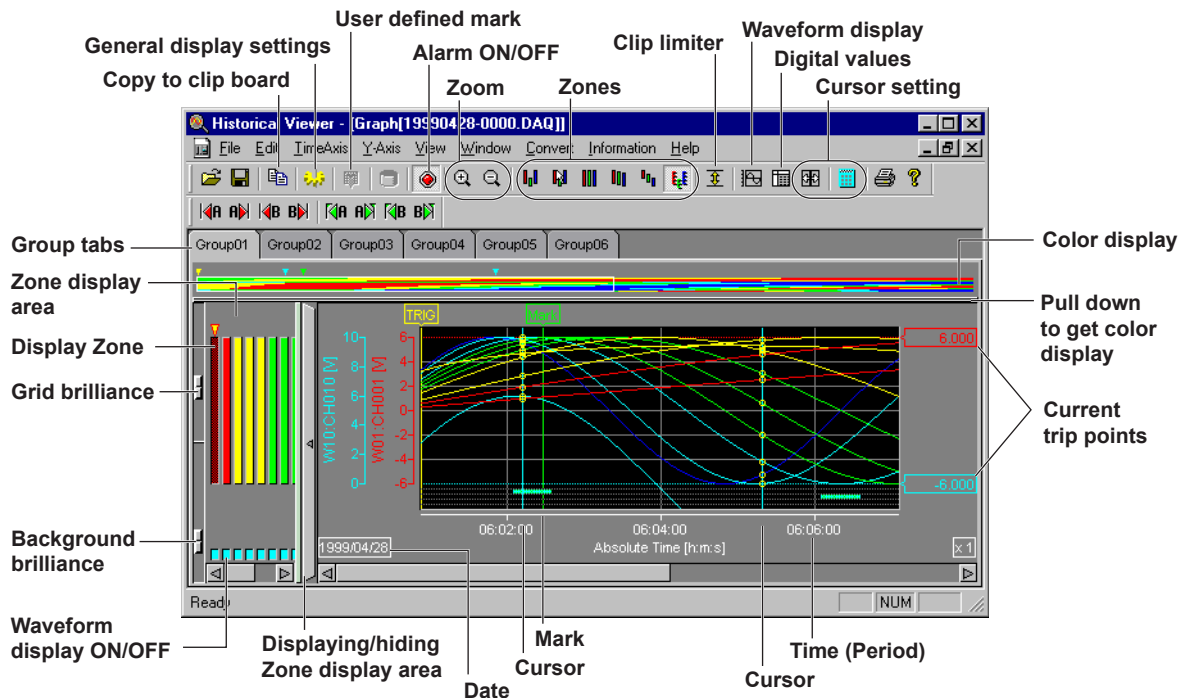

6.1 Introducing Historical Viewer Software

Digital value sheet

When a channel name is clicked the channel becomes active, which is displayed by the Active Channel marks.

Waveform display
Digital value display

Channel number, tag number, or tag comment
Display color

Group01	Group02	Group03	Group04	Group05	Group06
Date [No.]	W01:CH001 [V]	W02:CH002 [V]	W03:CH003 [V]	W04:CH004 [V]	W05:CH005 [V]
1999/04/28 06:00:53.0[000000000]	0.295	0.569	0.882	1.173	
1999/04/28 06:00:54.0[000000001]	0.303	0.607	0.908	1.208	
1999/04/28 06:00:55.0[000000002]	0.312	0.624	0.934	1.242	
1999/04/28 06:00:56.0[000000003]	0.321	0.641	0.960	1.276	
1999/04/28 06:00:57.0[000000004]	0.330	0.659	0.986	1.310	
1999/04/28 06:00:58.0[000000005]	0.338	0.676	1.011	1.344	
1999/04/28 06:00:59.0[000000006]	0.347	0.693	1.037	1.377	
1999/04/28 06:01:00.0[000000007]	0.356	0.710	1.063	1.411	
1999/04/28 06:01:01.0[000000008]	0.364	0.728	1.088	1.445	
1999/04/28 06:01:02.0[000000009]	0.373	0.745	1.114	1.479	
1999/04/28 06:01:03.0[000000010]	0.382	0.762	1.140	1.512	

Ready NUM

6.2 Opening Files for Display

The following data files can be displayed:

- Measurement data files/report files acquired with Logger software R9.
- Measurement data files currently being recorded with Logger software. (Data can not be displayed when the Historical Viewer is opened from the Start menu.)
- Measurement data files saved to a floppy disk with a DR or DC100.
- Measurement data files/report files acquired with the earlier Yokogawa software for DOS or Windows, Standard Software, Basic Software, Enhanced Software, or DAQ 32 R8 or later/DAQ 32 Plus R8 or later.
- Report files created with DA100/DC100/DR. (See also Section 6.18, "Displaying, Converting, and Printing Report Files")

- 1 To open a file, click the File Open button, from the toolbar, or select File > Open.

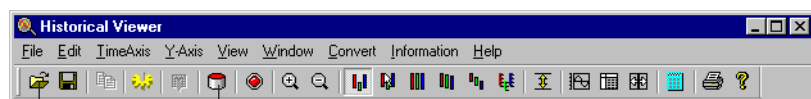

File open button Display recorded waveform

- 2 Select a file from the file Open listbox.

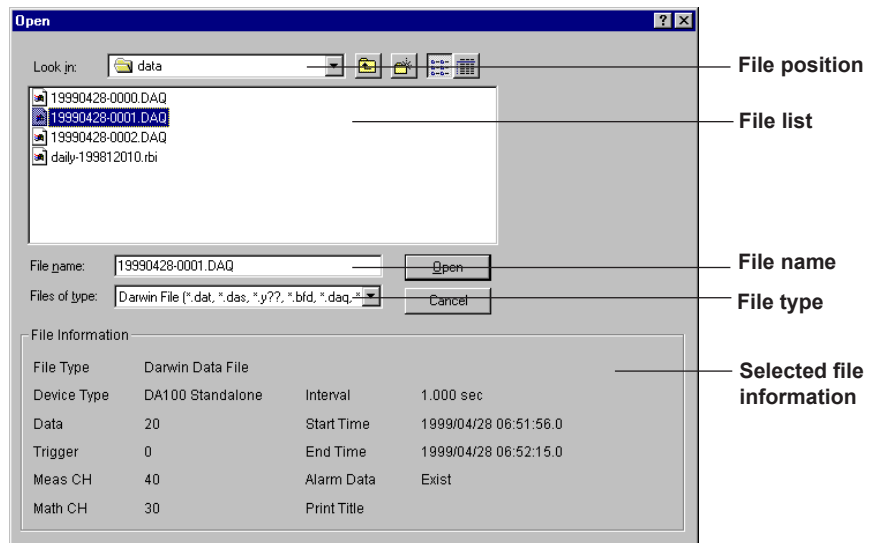

- 3 Click Open to display the desired waveform.
- 4 For big files (more than 10 MB to load), the Select option dialog box (below) opens asking you how to load the data file.
- 5 Select to read necessary data only, or to read all data.
 - Read necessary data only (minimum memory):
 - Read all data (Fast Update): Reading speed will be fast, but a lot of memory space will be used.
- 6 Click Select to display the waveform.

6.2 Opening Files for Display

Note

- It is possible to open several data files simultaneously.
 - The amount of files that can be opened simultaneously depends on the memory size and free harddisk space of your PC.
 - It is recommended to load data files, to your harddisk using a floppydisk.
 - Data files must have "DAT", "DAS", "Y**", "BFD", or "DAQ" extensions to be opened. The extension for report files must be "RBI." File info is displayed if you select File > Open.
 - DARWIN acquired files can be loaded, even if they have other extensions than above.
 - When data are internally saved to a DC100 or DR floppydisk during a power failure, no data will be saved during the period of the power failure.
 - If cursors are set for points within a power failure period, no channel values will be displayed. No measurement data will be displayed in the Cursor value dialog box, and no computation results will be displayed in the computation result dialog box. Only data numbers and time will be displayed.
 - When displaying a data file with data collected during a power failure waveform display time values and digital time values may differ. In such a case, the digital values show the correct time.
 - If the selected file contains no data, Start Time and End in the File Information dialogbox (Information > About Document) will be the time initialized for your PC.
-

Displaying data as they are being recorded

- 1** Click the Current Data button from the Historical Viewer toolbar.
Data currently recorded with Logger software will get displayed.
- 2** To renew the recording screen to get the latest recorded data click the Current Data button again.

Note

- The Current Data button is only active if Logger data are being recorded.
 - Do not display it when starting Viewer from the Start menu. Data acquisition and saving will not execute correctly.
-

Viewing file info

To view information on the active data file which waveform is being displayed, select Information > About Document, to open below File Information window.

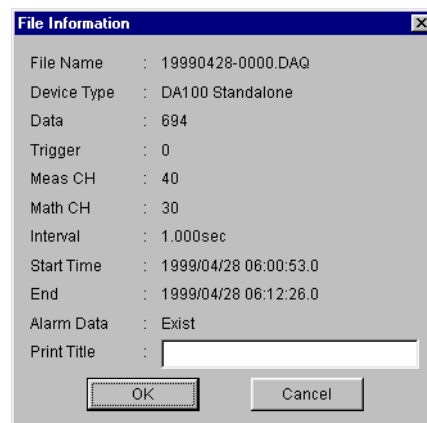

You may change the print title here. The title will be displayed in the Print setup dialog box (File > Print Preview), where you can also set a print title.

6.3 General Display Settings

- 1 Select View > General Display Settings... , or click the General Display Settings button to open the General Display Settings dialog box.

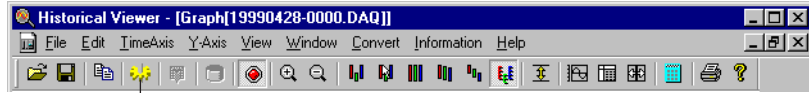

General Display Settings button

General Display setting dialog box

The dialog box is titled "General Display Settings" and contains a table of settings for various channels. The table has columns for Group Name, Linear/Log, Display scale, Display zone, and Setting trip point display ON/OFF. The table is annotated with various labels and arrows pointing to specific settings.

Group Name	Linear/Log	Display scale	Display zone	Setting trip point display ON/OFF
01				
02				
03				
04				
05				
06				
07				
08				
09				
10				
11				
12				
13				
14				
15				
16				
17				
18				
19				
20				
21				
22				
23				
24				
25				
26				
27				
28				
29				
30				

Annotations in the image include:

- Setting Y-axis display ON/OFF
- Group tabs
- Trip settings
- Color display
- Set all trip points ON/OFF
- Set to initial values
- Waveforms all ON/OFF
- Select same scale for all waveforms
- Scale Math
- Select copy items
- Copy
- Paste
- Set same zone as first zone for all

- 2 Click the tab of the group you want to open.
- 3 Enter a group name with up to 16 characters in the group name textbox.
- 4 Select the channel you wish to record in the group. Select a channel number and an overview of the channel numbers will appear. The channel you select here will be recorded. If you wish to record channel display with a tag or tagID instead of a number, make the changes on the monitor screen.
- 5 Click the boxes in front of the waveform numbers on the left (W01 to W32), to select which data you want to be displayed.
- 6 If Multi-Axis Zone is selected for the waveform display, you can select whether or not to display the Y-axis. You can also choose between Linear, and Log Y-axis display.

Click the square on the left of the Y-axis setting box to display (blue color), or hide the Y-axis. If you want to display the Y-axis, additionally click linear or log.
- 7 Set the maximum and minimum Scale.

Note

The input range is between -10^{16} to 10^{16} , excluding decimal points. Additional decimal points will automatically be round off depending on the measured data and scale.

6.3 General Display Settings

8 Set the waveform display area (Zone).

Note

- If the highest and lowest scale values are the same, then the highest setting will automatically be increased with 1, and the lowest setting value will be decreased with 1.
 - The lowest setting range for the Zone is 0 to 99%, the highest is 1 to 100%.
 - In the waveform monitor display area, the lowest value is 0%, the highest value is 100%.
-

A trip point sets the position of a horizontal line on a waveform display you can use to highlight specific values. You can set two different trip points. Trip point 1 is displayed in red, trip point 2 in blue.

9 Set Trip point 1 and Trip point 2 ON (blue) or OFF for each channel.

10 Enter the appropriate Trip point 1 and Trip point 2 value.

Note

- The trip points actually displayed in the waveform display area are the trip points for the active waveform.
 - The Trip value must be within the Scale value set for each channel.
 - You can change the position of the horizontal 'trip' lines by dragging the trip point labels on the right side of the waveform display area with the mouse.
 - Display will be set ON, when you set a Trip point. Click the Trip checkbox if you don't want the Trip to be displayed.
-

11 Click in the color channel of each channel to display the Color setting box. Select the desired color and click OK.

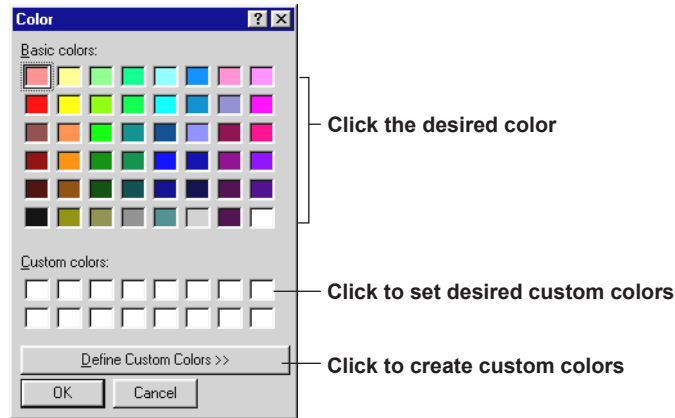

To make your own colors, click Define Custom Colors >>. The dialog box below for setting custom colors appears. Set the desired hue, brilliance and brightness. After setting the custom color, click Add to Custom Colors. Click OK to save the colors.

12 To apply click OK (the General Display Settings dialog box will disappear), or Apply, if you wish to keep the General Display Settings dialog box open.

Copy the Settings

To copy settings made for one channel to other channels, do as follows:

- 3 Click Copy Setting, to display the Copy Setting dialog box.

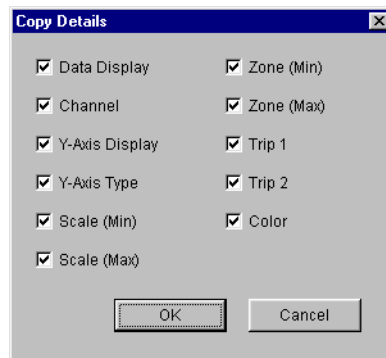

- 4 Click the desired copy items and click OK.
- 5 Click the copy base channel. The display color will change.
- 6 Click the Copy button.
- 7 Click the waveform numbers you want to copy the base settings to. The display color will change. Drag the mouse point down from the first to the last waveform, if you wish to copy to a successive series of waveforms.
- 8 Click the Paste button, copy the base channel to the selected channels.

Setting the largest and smallest scale

- 3 Click the object Waveform number. If the settings are for a group of successive waveforms drag the mouse from the first to last waveform.
- 4 Click the Scale Calc. button, to set each waveform to the calculated maximum and minimum scale.

Note

If no channels are selected, all waveforms will be set to their calculated maximum and minimum scale.

6.4 Setting Zones and the Y-Axis Clip

Selecting the waveform display zone

Use the zone buttons on the monitor toolbar (below), or select Y-Axis > and the desired zone.

Select the Edit Zone, User Zone, Full Zone, Slide Zone, Auto Zone, or Multi-Axis Zone.

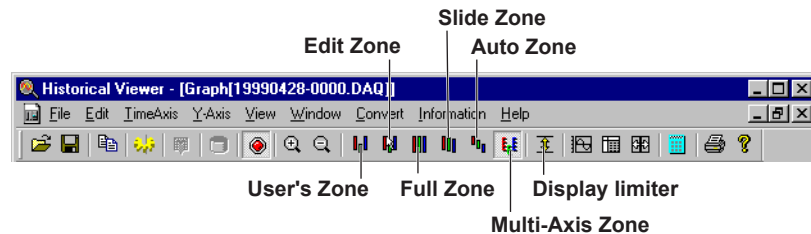

- **User Zone**

The User Zone shows Edit Zone settings, but these zone settings can not be changed.

- **Edit Zone**

If the Edit Zone is selected, it is possible to change zones simply by pulling the channel zone indicators, on the right of the window on right side of the waveform display window up and down.

Click the button on the top or bottom of the channel zone indicator and pull it up or down to enlarge or reduce a channel zone.

The zone settings will be reflected in the General Display Settings dialog box.

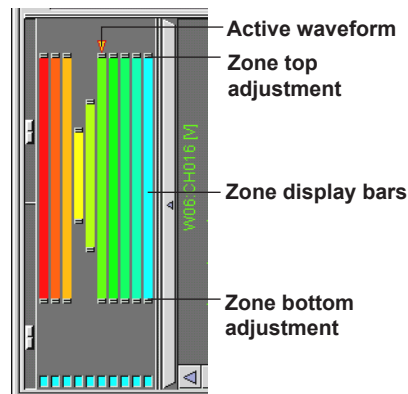

- **Full Zone**

Use the Full Zone to display all waveforms in a 100% zone range.

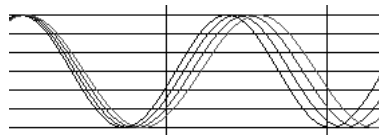

- **Slide Zone**

In Slide zone all waveforms scales are shifted slightly from top to bottom.

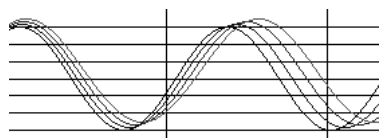

- **Auto Zone**

In Auto Zone the Y-axis of the waveform display area is divided into equal parts for each selected waveform.

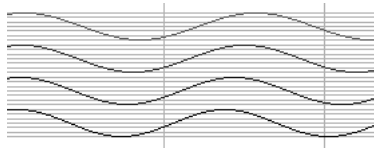

- **Multi-Axis Zone**

Displaying multiple Y-axis.

Select an axis for display as follows:

- Use the General Display Settings (See Section 6.3, General Display Settings).
- You can drag and drop zone display bars, to and from the Y-axis display area in the waveform display.

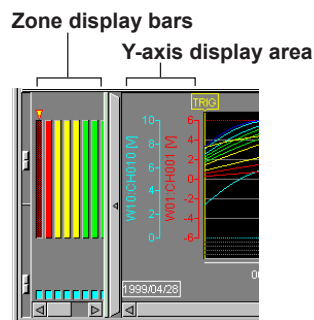

Setting the Y-axis display limiting Clip

It's possible to apply a display limit to waveforms you view. When you set the display limit function, waveforms will be limited between the minimum and maximum values on the Y-Axis scale. Waveforms with data points smaller than the minimum scale value or larger than the maximum scale value will be truncated. This function enables you to view waveforms outside the screen range as horizontal lines in the display area.

- Waveform with clip :



- Waveform without clip :



6.5 Setting the Waveform Time Axis

Displaying the complete waveform

Select TimeAxis > All, to display to display the complete waveform on the TimeAxis.

Time Axis Zoom

Historical Viewer allows two ways to zoom waveforms in X-Axis direction:

- Easily enlarge / reduce a waveform using the **Auto Zoom** function.
- **Exact Zoom** using the TimeAxis > Set Scale... function.

- **Auto Zoom**

To enlarge waveforms in TimeAxis direction, select TimeAxis > Zoom In, or click the Zoom In button on the toolbar (see below).

To reduce a waveform in TimeAxis direction, select TimeAxis > Zoom Out, or click the Zoom Out button on the toolbar (below).

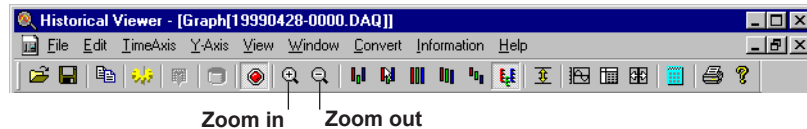

- **Exact Zoom**

If you wish to set the zoom factor more precise, do as follows:

- 1 Select TimeAxis > Set Scale.

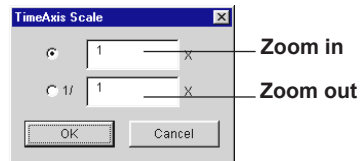

- 2 To enlarge a waveform, enter the magnification factor in the upper box. To reduce a waveform, enter the reduction factor in the lower box.

- 3 Click OK.

The waveform appears enlarged/reduced in the TimeAxis direction.

Note

- Set an integer between 1 and 20 as magnification factor .
Magnification factor 5 means that 5 data items per vertical monitor line are displayed.
Set the reduction factor between 1/1 and 1/1000.
Reduction factor 1/500 means that 1 data item per 500 vertical monitor lines is displayed.
- If a cursor is set, it will be the center of the zoom action if the first data is not displayed.
- If cursor A and B are set, the midpoint of the two cursors become the center of the zoom action if the first measurement data is not displayed.

Changing the scale display of the TimeAxis

To change the Time Axis of the waveform display, select TimeAxis > and Absolute Time, or Relative Time from the Trend monitor menubar.

- Absolute time shows the actual time during display.
- Relative time shows the time lag from the first displayed data.

Note

- The time axis scale will change automatically, depending on the display time range.
- When data were collected with an external sampling clock, the data number scale will get displayed on the Time Axis. Time will get displayed in the digital value sheet.

6.6 Cursor Measurement

It is possible to read time and measurement data values on the X-Axis using two cursors: cursor A and cursor B. This may be useful if you want to know the time or voltage difference between two occurrences. Use the cursors as follows:

- 1 Point the mouse at the position in the waveform display area where you want to read measurement data. The vertical bar that appears is cursor A. Hold the mouse and drag the pointer to the next position where you want to read measurement data. Cursor B gets set when you release the mouse.

Example of cursor display:

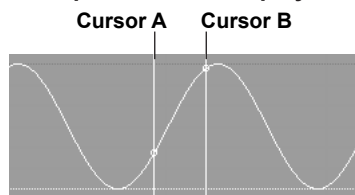

- 2 To display the cursor values, select Window > Control, or click the cursor Control button on the toolbar (below).

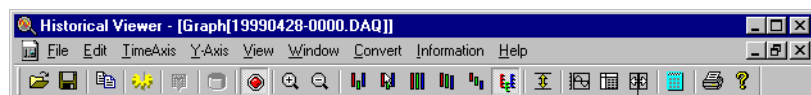

Cursor control button

In the cursor Control dialog box you can now read measurement values at the cursor positions and the value difference between the two cursors positions.

If you wish to accurately adjust the position of a cursor, click the arrow buttons next to data No. values in the cursor Control dialog box. The cursor will move in steps of one data item.

Cursor's Value			
	Cursor A	Cursor B	Difference
Data No.	18	61	43
Absolute Time	1998/10/28 20:16:48.0	1998/10/28 20:17:31.0	00:00:43.0
Channel	Value A	Value B	B - A
CH001[V]	0.442	0.814	0.372
CH002[V]	0.883	1.614	0.731
CH003[V]	1.318	2.384	1.066
CH004[V]	1.747	3.110	1.363
CH005[V]	2.166	3.778	1.612
CH006[V]	2.573	4.376	1.803
CH007[V]	2.966	4.893	1.927
CH008[V]	3.343	5.319	1.976

Use to move cursors

Alarm display

- 3 To erase cursors from the waveform display area, select View > Erase Cursor. After doing this, no values will remain in the cursor Control dialog box.

6.6 Cursor Measurement

Note

- To easily put cursor's at the first and last measurement data, select Edit > Select All, from the menubar.
 - Cursors will appear both on the waveform and on the digital value sheet.
 - If a different display group is selected, cursors will appear in the same position on that display.
 - When you move a cursor in the waveform display using your mouse while the Cursor Value window is still open, values in the Cursor Display window will also change.
 - To move only cursor A in the display screen, press the Control button, and click on the position where you want the A cursor to appear. To move only cursor B in the display screen, press the Shift button, and click on the position where you want the B cursor to appear.
-

6.7 Using Cursors to Search for Alarms and Marks

In this section read how to move cursors to positions where alarms are (de-) activated for active channels, and how to move cursors to mark positions.

- 1 Set cursor A and B on the waveform or digital value display area. For details on cursors, see Section 6.6, "Cursor Measurement."

Searching for alarms

- 2 Click the Search Alarm button, or select from the menubar Edit > Search Alarm, followed by Right move cursor A, Left move cursor A, Right move cursor B, or Left move cursor B. Cursor A or B will move to the nearest position where alarms are (de-) activated on the right or left side of the cursor in the active channel. The cursor won't move when there is no corresponding alarm.



Alarm search buttons
Mark search buttons

Searching for marks

- 2 Click the Search mark button or select Edit > Mark, followed by Right move cursor A, Left move cursor A, Right move cursor B, or Left move cursor B. Cursor A or B will move to the nearest mark position on the right or left side of the cursor in the active channel. The cursor won't move when there is no corresponding mark.

Note

"Marks" include trigger marks.

6.8 Using Cursors for Statistical Calculations

You can view five different statistical calculations on the data between cursor A and B:

- Maximum value.
- Minimum value.
- Peak-to-peak (P-P) value.
- Average value.
- Root-mean-square (RMS) value.

- 1 Place cursor A and B as explained in Section 6.6.
- 2 To view the statistical calculations select Window > Statistics, or click the Statistics button on the toolbar (see below).

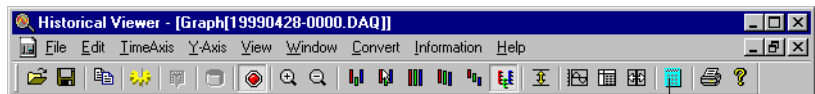

Statistics button

The below Statistics window will open.

First section		Last section			
Section	142	-	318		
Channel	Min	Max	P-P	Mean	RMS
WD1:CH011	-5.999	2.063	8.062	-3.645	4.360
WD2:CH012	-5.999	0.584	6.583	-3.858	4.283
WD3:CH013	-5.999	1.956	7.955	-3.473	4.132
WD4:CH014	-5.999	4.471	10.470	-2.639	4.160
WD5:CH015	-5.999	5.854	11.853	-1.563	4.393
WD6:CH016	-5.999	5.999	11.998	-0.471	4.622
WD7:CH017	-5.999	5.999	11.998	0.444	4.644
WD8:CH018	-5.999	5.999	11.998	1.052	4.421

Note

- If you wish to view the statistical calculations on data at different cursor positions, reposition the cursors. If you proceed in this way it is not necessary to close the Statistics window.
- The Statistics window displays the statistics of the group in the active window, regardless if a waveform is displayed or not.
- The size of the Statistics window can't be altered. Use the scroll bar to view other channel results.
- If no cursors are being used, statistics from the first to last channel will be displayed.

6.9 Notepad Copying

To copy digital waveform data between cursors to your PC's notepad do the following:

- 1 Set the data range you wish to copy with your mouse pointer on the digital value sheet, or using cursor A and B in the waveform display area.
- 2 To copy the selected data to your notepad select Edit > Copy, or use the Copy button on the toolbar (see below).

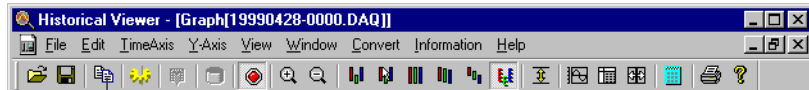

Copy button

Note

- You can copy a maximum of 1000 data sets to your notepad.
- If you copy to a notepad, data of all channels will appear (even data of channels not actively displayed).
- The relative Time or a Time period will appear on the notepad, depending on the TimeAxis display mode.
- You can use the notepad data if you add them to your application software.

6.10 Displaying Alarm Info

Alarm info can be displayed on the waveform screen, on the digital value Sheets, and in the cursor control dialog box.

Click the Alarm button on the toolbar (below), or select Display > Alarm.

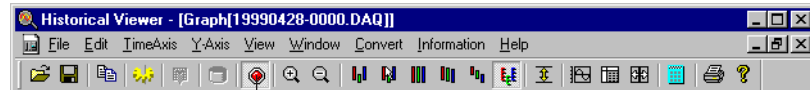

Alarm button

Waveform display

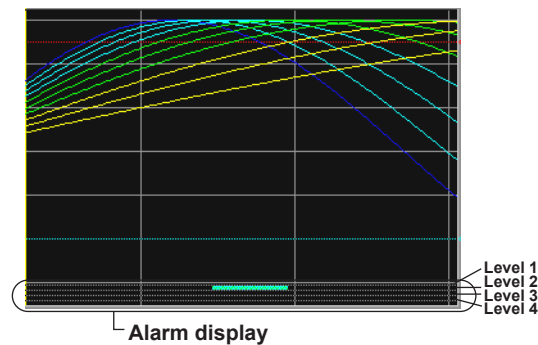

Alarm display

Digital value sheets

Date [No.]	W01:CH025 [V]	W02:CH026 [V]	W03:CH027 [V]	W04:CH [V]
1998/10/19 16:30:15.0[00000000]	5.560	5.679	5.765	
1998/10/19 16:30:16.0[00000001]	5.656	5.748	5.825	
1998/10/19 16:30:17.0[00000002]	5.725	5.808	5.877	
1998/10/19 16:30:18.0[00000003]	5.786	5.861	5.920	
1998/10/19 16:30:19.0[00000004]	5.840	5.905	5.953	
1998/10/19 16:30:20.0[00000005]	5.886	5.941	5.978	
1998/10/19 16:30:21.0[00000006]	5.924	5.968	5.993	

Alarm Indicator

Level 1 Level 2 Level 3 Level 4

Cursor control dialog box

Cursor A	Cursor B	Difference	
Data Number 89	283	174	
Absolute Time 1998/10/00 20:35:46.0	1998/10/00 20:36:40.0	00:02:54.0	
Channel	Value A	Value B	Value B-A
W01:CH011[V]	5.584	-5.999	-11.583
W02:CH012[V]	5.111	-5.436	-10.547
W03:CH013[V]	4.479	-3.886	-8.365
W04:CH014[V]	3.707	-1.632	-5.339
W05:CH015[V]	2.819	0.918	-1.901
W06:CH016[V]	1.843	3.301	1.458
W07:CH017[V]	0.810	5.086	4.276
W08:CH018[V]	-0.247	5.949	6.196

Alarm display

Note

- If alarm display is set ON or OFF in any of the above displays, the same will happen in any of the other displays
- Alarms of the active waveform will get displayed. In the waveform display the alarms will get displayed in the color of the waveform with an alarm occurrence.
- If there are no alarm data in the loaded file, selecting View > Alarm will not be possible.

6.11 Selecting Channel, Tag No., or Tag Comment display

You can choose to view channels labeled with a channel number, a Tag No. or a Tag Comment. Select View > Channel No., Tag No., or Tag Comment.

Changing channel labels will have effect on labeling of the waveform Y-Axis, the Digital Sheet Window, the cursor Control window, the Statistics dialog box, and on the labeling of the General Display settings.

6.12 User Defined and Trigger Marks

There are two kinds of vertical bar marks, User Defined marks, and Trigger marks.

User Defined marks

User Defined marks are green marks added to and removed from arbitrary points on the X-axis.

Set User Defined Marks in the following manner:

- 1 Place the mouse pointer —either in the waveform or digital Sheet area— at the position where you wish to add a User Defined mark.
- 2 Select Edit > Append Mark..., or click the Add Mark button on the toolbar (see below).

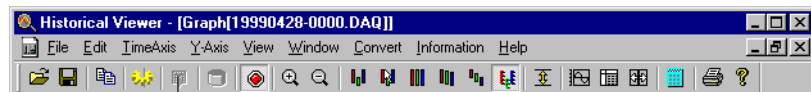

User Defined mark

- 3 Enter a name in the Mark Setting text box.

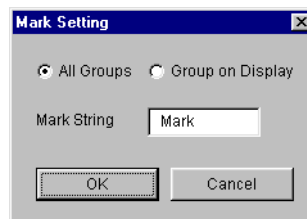

- 4 Click OK.

You can set as many user defined marks as you like by repeating steps 1 to 4.

The name of the User Defined marks appear above the waveform display area.

To change the name of a mark, double-click the mark to be changed, and repeat step 3 and 4.

Trigger marks

Trigger marks are yellow marks indicating where a trigger took place at the time the data were acquired with a DARWIN device.

You may change the name of the trigger mark in the same way as described above.

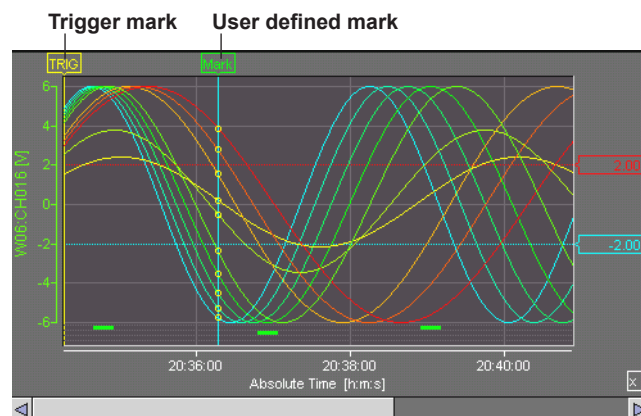

Note

- You can not set more than one User Defined mark at once.
 - In the waveform display area User Defined marks are colored green, Trigger Marks are yellow. On the digital value Sheet, User Defined mark are indicated by a green flag, Trigger Marks by a yellow flag.
-

Deleting Marks

To delete marks from the waveform display area:

- 1** First capture them between cursor A and B.
- 2** Then select Edit > Delete Mark.

Both Trigger marks and User Defined marks in the captured range will be deleted.

Resetting Marks

If you wish to reset User Defined marks select Edit > Reset Mark.

All User Defined marks will be deleted. If you deleted the trigger mark it will be reset.

6.13 Saving Display Conditions

It is possible to save waveform and digital value Sheet conditions to a file.

Note that of one measurement data file, only one display condition can be saved. If you save new data, they will overwrite data you saved earlier to the file.

To save display conditions, select File > Save Display Settings, or click the Save Display Settings button on the toolbar (see below).

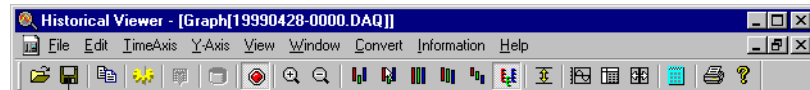

Save Display Settings button

The file name will be the name of the displayed data file, plus the extension .ddw.

For example If the filename was abcde.dat, the saved file's name will be abcde.dat.ddw.

Note

- The following information is saved to the file:
 - Waveform display area.
 - Active waveform
 - Brightness of waveform and grid.
 - Printing title.
 - Positions of cursor A and cursor B.
 - General display setting conditions.
 - Selected Group
 - Displayed waveform timing On/Off.
 - Y-axis details (channel No., waveform display On/Off, scale, zone, trip point 1, trip point 2, waveform color).
 - Selection of channel No./Tag/Tag ID.
 - Mark information.
 - X-axis magnification factor.
 - X-Axis scale (Time, Data No., etc).
 - Logic display On/Off.
 - Y-Axis zone (Auto, User, Full, or Slide zone).
 - Alarm display condition.
- The file with display conditions will be saved to the directory in which the data file was saved.
- The display conditions file can be unlimitedly overwritten.

6.14 Converting the Data Format

With waveforms or digital values displayed, you can convert measurement data into one of three data formats, ASCII, Lotus 1-2-3 and Excel.

- 1 Select Convert > and, to ASCII, to Lotus, or to Excel.
- 2 Using each xxx Conversion Details dialog box, enter the range of the data to be converted (the first and last data point) and the step (e.g. if you enter “3”, two out of three consecutive data items are skipped; to convert all of the data in the specified range, enter “1”). Click the check box of each channel which data you wish to convert.

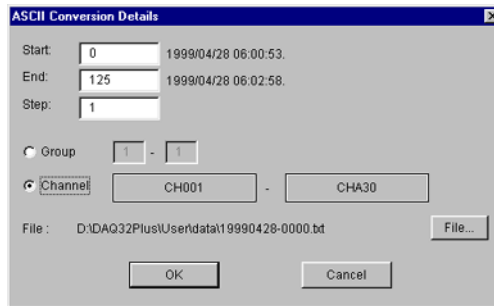

- 3 Select Group or Channel, and enter the desired values in the textbox. When selecting Group, enter the desired values in each textbox. When selecting Channel, first click the Channel No. buttons to open a Channel number table, and then click the desired channel number. The table will be closed and the channel number will be input.

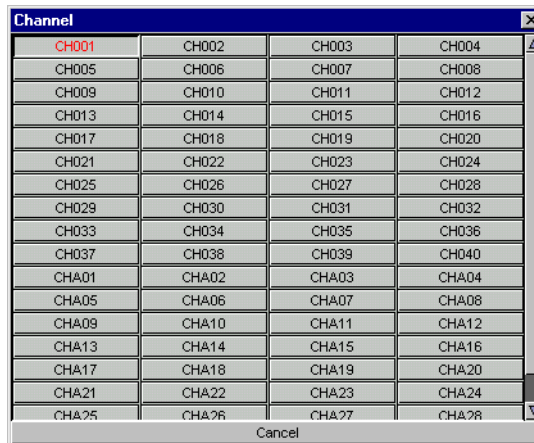

- 4 If you wish to save to a different folder or file, click File... .
Select a file name from the File Name box, or type a file name in the text box. If necessary, select the type of folder or file in which the data is to be saved.
Click Save.

6.14 Converting the Data Format

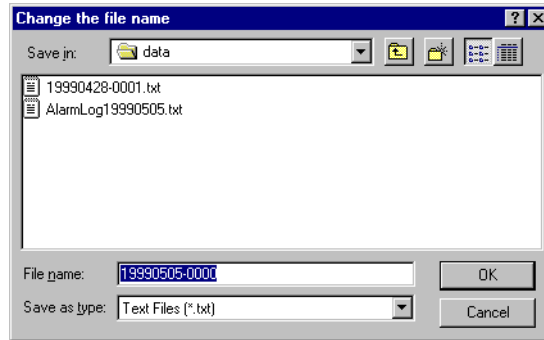

- 5 Click OK in the xxx Conversion dialog box.

The measurement data is converted into the selected data format, and saved in a file.

Note

- The range of the data you wish to convert, indicated in each xxx Conversion dialog box, is automatically set to the range specified by cursor A and B. If the range is not specified by the cursors, or if the cursors have been deleted, the first data point is automatically set to 0, the final to the last recorded data point minus 1.
 - The file extension of the converted file is automatically changed to the following format names, to distinguish it from the original file: Excel conversions (possible for version 4.0 or higher) get the extension "xls", ACSII files "txt", and Lotus (possible for version 2.0 or higher) files get the extension "wj2."
 - For Lotus 1-2-3 and Excel there is a limit to the data that can be read. When the memory of your PC is not sufficient, data may not be read even though the data limit is not exceeded.
 - Files with converted formats are saved to the same directory as the original.
 - Do not select external media like floppy disk to save data.
 - Do not select save data in a root directory.
 - Make sure there is enough memory before saving data.
-

Converted File Formats

Converted data should appear on your screen similar to the following examples:

- Example of an **ASCII**-converted file.

```
"DAQ32 Plus Data Viewer (R11.01.01) Software ID XXX-XXXX-XXXX"
"Start Time","1998/10/14","16:59:35.0"
"End Time","1998/10/14","17:02:37.0"
"Sample Rate (Sec)", 1.0
"Data Count", 183
"Group","01-01"
"Ch. No.," 001"," 002"," 003"," 004"," 005"," 006"," 007"," 008","
009"," 010"," 011"," 012"
"Tag
No.,"TAGID001","TAGID002","TAGID003","TAGID004","TAGID005","TAGID006",
"TAGID007","TAGID008","TAGID009","TAGID010","TAGID011","TAGID012"
"Tag Commnt","TAG-CH001 ","TAG-CH002 ","TAG-CH003
","TAG-CH004 ","TAG-CH005 ","TAG-CH006 ","TAG-CH007
","TAG-CH008 ","TAG-CH009 ","TAG-CH010 ","TAG-CH011
","TAG-CH012 "
"Unit","V ","V ","V ","V ","V ","V ","V "
","V ","V ","V ","V ","V ","V "
"YYYY/MM/DD HH:mm:ss.S"
"1998/10/14 16:59:35.0", 0.745, 1.480, 2.191, 2.868,
3.501, 4.080, 4.595, 5.039, 5.404, 5.686, 5.880,
5.983
"1998/10/14 16:59:36.0", 0.754, 1.496, 2.215, 2.899,
3.536, 4.118, 4.634, 5.076, 5.438, 5.713, 5.898,
5.989
"1998/10/14 16:59:37.0", 0.763, 1.513, 2.239, 2.929,
3.571, 4.155, 4.672, 5.113, 5.471, 5.739, 5.915,
5.995
```

- Example of a **Lotus**-converted file.

A	B	C	D	E	F
1	DAQ32 Plus Data Viewer	R11.01.01		Software ID XXX-XXXX-XXXX	
2	Start Time	1999/04/20		08:49:13.0	
3	End Time	1999/04/20		09:02:35.0	
4	Sample Rate	1.0	Sec		
5	Data Count	803			
6	Group	01	-	01	
7		Ch.	CH001	CH002	CH003
8		Tag No.	TAGNO001	TAGNO002	TAGNO003
9		Tag Comment	TAG-COMMENT-001	TAG-COMMENT-002	TAG-COMMENT-003
10	Date	Time	msec	V	V
11	04/20	08:49:13	0.0	0.676	1.344
12	04/20	08:49:14	0.0	0.685	1.361
13	04/20	08:49:15	0.0	0.694	1.378
14	04/20	08:49:16	0.0	0.702	1.395
15	04/20	08:49:17	0.0	0.711	1.412

- Example of an **Excel**-converted file.

	A	B	C	D	E	F
1	DAQ32 Plus Data Viewer	R11.01.01		Software ID XXX-XXXX-XXXX		
2	Start Time	1999/04/20		08:49:13.0		
3	End Time	1999/04/20		09:02:35.0		
4	Sample Rate	1.0	Sec			
5	Data Count	803				
6	Group	01	-	01		
7		Ch.	CH001	CH002	CH003	
8		Tag No.	TAGNO001	TAGNO002	TAGNO003	
9		Tag Comment	TAG-COMMENT-001	TAG-COMMENT-002	TAG-COMMENT-003	
10	Date	Time	msec	V	V	V
11	04/20	08:49:13	0.0	0.676	1.344	
12	04/20	08:49:14	0.0	0.685	1.361	
13	04/20	08:49:15	0.0	0.694	1.378	
14	04/20	08:49:16	0.0	0.702	1.395	
15	04/20	08:49:17	0.0	0.711	1.412	

6.15 File Formats

In this section you can find ASCII file format.

ASCII file converted format

Title	CR	LF
First data acquisition time	CR	LF
Last data acquisition time	CR	LF
Measurement interval	CR	LF
Data count	CR	LF
Group	CR	LF
Channel number	CR	LF
Tag No.	CR	LF
Tag Comment	CR	LF
Unit	CR	LF
Date format	CR	LF
Data number, All channel data (Continuous data numbers)	CR	LF

Title

1	2	3	4	5	6	7	8	9	10	11	12	13	14	15	16	17	18	19	20
"	D	A	Q	3	2		P	I	u	s		D	a	t	a		V	i	e

21	22	23	24	25	26	27	28	29	30	31	32	33	34	35	36	37	38	39	40
w	e	r		(R	X	X	.	X	X	.	X	X)		S	o	f	

41	42	43	44	45	46	47	48	49	50	51	52	53	54	55	56	57	58	59	60
w	a	r	e		I	D		X	X	X	-	X	X	X	X	X	-	X	X

61	62	63	64	65
X	X	"	CR	LF

RXX.XX.XX is the Software revision number. The Software ID in this software is "XXX-XXXXX-XXXX."

Acquisition time, first data

1	2	3	4	5	6	7	8	9	10	11	12	13	14	15	16	17	18	19	20
"	S	t	a	r	t		T	i	m	e	"	,	"	1	9	9	8	/	0

21	22	23	24	25	26	27	28	29	30	31	32	33	34	35	36	37	38
3	/	3	1		0	1	:	0	2	:	0	0	.	5	"	CR	LF

Acquisition time, last data

1	2	3	4	5	6	7	8	9	10	11	12	13	14	15	16	17	18	19	20
"	E	n	d				T	i	m	e	"	,	"	1	9	9	8	/	0

21	22	23	24	25	26	27	28	29	30	31	32	33	34	35	36	37	38
3	/	3	1		2	3	:	5	9	:	5	9	.	0	"	CR	LF

Sample rate

1	2	3	4	5	6	7	8	9	10	11	12	13	14	15	16	17	18	19	20
"	S	a	m	p	l	e		R	a	t	e		(S	e	c)	"	,

21	22	23	24	25	26	27	28	29	30	31	32
Data acquisition interval										CR	LF

Example of data acquisition interval (0.5 sec, and 60 sec)

21	22	23	24	25	26	27	28	29	30
						6	0	.	5
							0	.	0

Data count

1	2	3	4	5	6	7	8	9	10	11	12	13	14	15	16	17	18	19	20
"	D	a	t	a		C	o	u	n	t	"	,	Data count						

21	22	23	24	25
			CR	LF

Example of data count (100 data, and 120000 data)

15	16	17	18	19	20	21	22	23
			1	2	0	1	0	0
						0	0	0

Group

1	2	3	4	5	6	7	8	9	10	11	12	13	14	15
"	G	r	o	u	p	"	,	"	0	2	-	1	0	"

If a group was converted, the group's channel range will be displayed here.
If a single channel was converted the group range will be empty.

6.15 File Formats

Channel number

1	2	3	4	5	6	7	8	9	10	11	12	13	14	15	16	17	18	19	20	
"	C	H	.		N	o	.	"	,	channel number						,	channel			

21	22	23	24													?	?		
number			,	CR	LF

One channel number occupies 6 character spaces, including double quotation marks. One channel number can't be longer than 4 alphanumeric.

Example of channel number (Measurement channels 001 and 320. Math channel A20)

10	11	12	13	14	15
"		0	0	1	"
"		3	2	0	"
"		A	2	0	"

Tag No.

1	2	3	4	5	6	7	8	9	10	11	12	13	14	15	16	17	18	19	20
"	T	a	g		N	o	.	"	,	Tag No.									

21	22	23	24	25	26	27	28	29	30	31						?	?		
,	Tag No.										CR	LF

One Tag No. occupies 10 character spaces, including double quotation marks. After a Tag No. with less than 8 alphanumerics, spaces will appear. A Tag No. can't be longer than 8 alphanumerics.

Tag No. example (For Tag 0001)

11	12	13	14	15	16	17	18	19	20
"	T	A	G	0	0	0	1		"

Tag Comment

1	2	3	4	5	6	7	8	9	10	11	12	13	14	15	16	17	18	19	20
"	T	a	g		C	o	m	m	e	n	t	"	,	Tag Comment					

21	22	23	24	25	26	27	28	29	30	31	32	33				?	?		
												,	CR	LF

One Tag Comment occupies 18 character spaces, including double quotation marks. After a Tag Comment with less than 16 alphanumerics, spaces will appear. One Tag Comment can't be longer than 16 alphanumerics.

Tag Comment example (For Tag 0001)

15	16	17	18	19	20	21	22	23	24	25	26	27	28	29	30	31	32
"	T	A	G	0	0	0	1										"

Unit

1	2	3	4	5	6	7	8	9	10	11	12	13	14	15	16	17	18	19	20		
"	U	n	i	t	"	,	"	Unit						"	,	"	Unit				

21	22	23	24	25											?	?			
"				,	CR	LF

One Unit occupies 10 character spaces, including double quotation marks. After a Unit with less than 8 alphanumerics, spaces will appear. A Unit can't be longer than 8 alphanumerics.

Unit example (For Unit V)

8	9	10	11	12	13	14	15	16	17
"	V							"	

Date format

Time

1	2	3	4	5	6	7	8	9	10	11	12	13	14	15	16	17	18	19	20
"	Y	Y	Y	Y	/	M	M	/	D	D		H	H	:	m	m	:	S	S

21	22	23
.	S	"

Time period

1	2	3	4	5	6	7	8	9	10	11	12	13	14	15	16
"	D	D	D		H	H	:	m	m	:	S	S	.	S	"

Measurement time, and period

Time

1	2	3	4	5	6	7	8	9	10	11	12	13	14	15	16	17	18	19	20
"	Y	Y	Y	Y	/	M	M	/	D	D		H	H	:	m	m	:	S	S

21	22	23	24	25	26	27	28	29	30	31	32	33	34	35	36	37	38	39	40			
.	S	"	,	Measurement value									,	Measurement value								

21	22	23	24														??	??		
			,	CR	LF

Time period

1	2	3	4	5	6	7	8	9	10	11	12	13	14	15	16	17	18	19	20	
"	D	D	D		H	H	:	m	m	:	S	S	.	S	"	,	Measurement			

21	22	23	24	25	26	27	28	29	30	31	32	33	34	35	36	37	38	39	40	
value				Measurement value									,	Measurement value						

21	22	23	24														??	??		
			,	CR	LF

Time occupies 23 character spaces, time period 16, both including double quotation marks. One measurement value will take 9 spaces. Measurement values acquired during a power cut will appear as blanks.

Time example (for March 31, 1998, 22:30, 10.5 seconds)

1	2	3	4	5	6	7	8	9	10	11	12	13	14	15	16	17	18	19	20
"	1	9	9	8	/	0	3	/	3	1		1	0	:	3	0	:	1	0

21	22	23	24
.	5	"	,

Time period example (for three days, 10 hours, 30 minutes, and 10.5 seconds)

1	2	3	4	5	6	7	8	9	10	11	12	13	14	15	16
"	0	0	3		1	0	:	3	0	:	1	0	.	5	"

Example of measurement data

1	2	3	4	5	6	7	8	9	10
				1	0	.	1	2	,
			1	2	0	0	.	0	,

6.16 Outputting Data Divided with Cursors

This section explains how to use cursors to specify and divide desired data and how to save them.

- 1 Set cursor A and B to specify the desired data in the waveform or digital value display area. For details on cursors see Section 6.6, "Cursor Measurement."

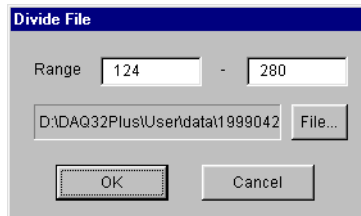

- 2 Select Convert > Divide... to open the Divide File dialog box.
- 3 Range shows the area specified with cursors. To change the range, enter the desired data numbers directly in the Range textbox.

Note

When no cursors are displayed, the initial range is from 0 to the last recorded data point.

Output file names

- 4 Click the File button to open the Save As dialog box. Select where to save the file, enter a file name, and select the type. Click OK to save.

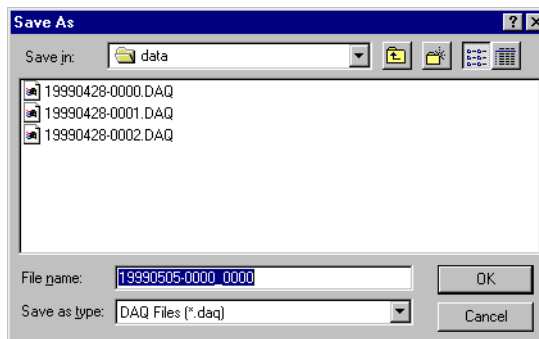

Note

- If no file name is entered, the file will be named: "the original file name.daq." When there are files with the same name, a follow-up number will be added to the original file name for distinction.

For example:

the original file name_0000.daq
(0000 being the follow-up number)

- Do not select external media like floppy disk to save data.
- Do not select save data in a root directory.
- Make sure there is enough memory before saving data.

- 5 Click OK to save. Click Cancel to close the dialog box without saving.

6.17 Printing Measurement Data

Printer Setting

Set your printer in the following manner:

- 1 Select File > Print Setup... .
- 2 Set the name of your printer, paper size and source, and print orientation in the Printer Setup dialog box (see below), and click OK.

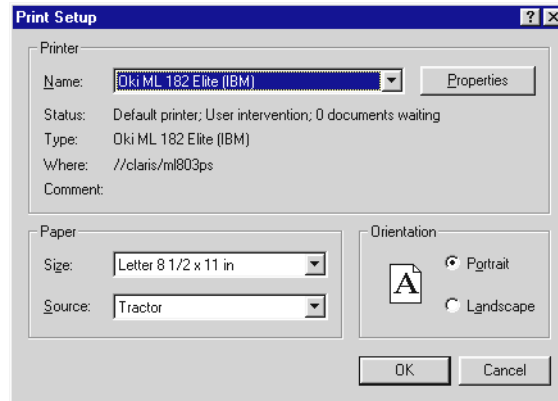

Print Settings

- 1 Select File > Print Settings ... to open the Print Settings dialog box..

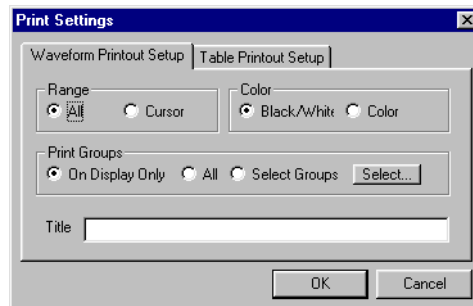

- Waveform Printout Setup

- 2 Select the Print Groups.

When selecting Select Groups, continue to click the Select button. In the Select Groups dialog box that opens, select the desired groups and click OK.

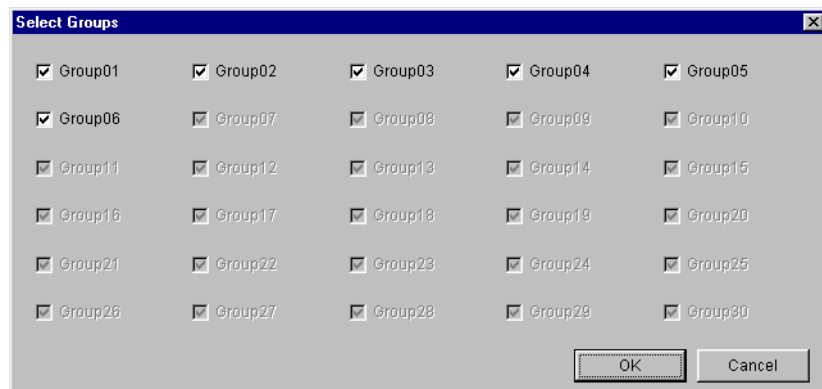

- 3 Enter a Title for the printout.

Note

- You can also enter or change the print title in the File Information dialog box. (Refer to Viewing file info on 6-4 page) The print title entered or changed here will reflect to the File Information dialog box.
- The Print Title can be up to 255 characters. However, make sure it fits on the paper printout.

4 Click OK to save the settings and close the dialog box.

• Table Printout Setup

2 Click the Table Printout Setup tab.

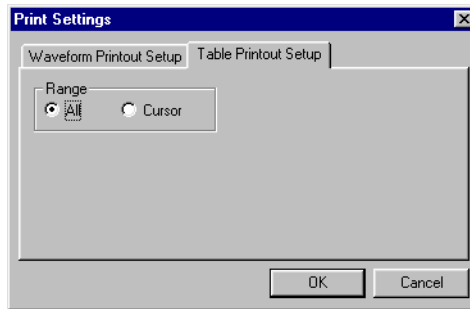

3 Select All values or the Cursor specified values as printing Range.

4 Click OK to save the settings and close the dialog box.

Note

The printing range is set using cursor A and B, as explained in Section 6.6, "Cursor Measurement."

Print Preview and Printing

To preview the pages you want to print, do as follows:

- 1 Select File > Print Preview.
- 2 Use the buttons on top of the Print Preview window to zoom or turn pages.
- 3 When you finish previewing, either click Close the Print Preview window to return the original screen or click Print to continue the printing procedure.

Printing

4 Click OK to start printing, or Cancel to abort printing.

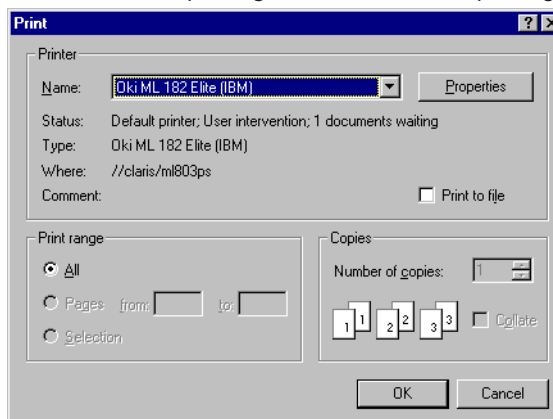
**Note**

- The print preview starts with the first file data.
- The print preview may slightly differ from the actual printout.
- Refer to the instruction manual of your own PC for further info on print preview operation.
- When the Cursor's Value or Calculate Results windows are on display when printing, those values will also appear on print.

6.18 Displaying, Converting, and Printing Report Data

This section explains how to view report files created with DA100/DC100/DR report function, and report files acquired with Logger software from DA100/DC100/DR. It also explains how to convert report file data into Excel/ASCII/Lotus 1-2-3 formats and how to print report files.

Vertical channel format

Hourly/Daily/Monthly reports, report ending time, (report starting time)

Historical Viewer - [Report[daily-199812010.rbi]]

File View Window Convert Help

Vert. CH Hor. CH

Daily Report 1998/12/01 00:00 (Start = 1998/11/30 16:27)

RCH	Channel	Tag No.	Tag Comment	Mode	Unit	1998/12/01 00:00	
						INST/AVE/SUM	MIN/TOTAL
R01	CH101			INST	V	0.3900	
R02	CH101			AVE	V	0.3834	
R03	CH101			SUM	V	20802.5486	20802.5486
R04	CH101			SUM	V	10401.2743	10401.2743
R05	CH101			SUM	V	173.3546	173.3546
R06	CH101			SUM	V	2.8892	2.8892
R07	CH101			SUM	V	0.1204	0.1204
R08	CH111			INST	V	0.0001	
R09	CH111			AVE	V	0.0000	
R10	CH111			SUM	V	0.7416	

Ready NUM

Horizontal channel format

Hourly/Daily/Monthly reports, report ending time, (report starting time)

Historical Viewer - [Report[daily-199812010.rbi]]

File View Window Convert Help

Vert. CH Hor. CH

Daily Report 1998/12/01 00:00 (Start = 1998/11/30 16:27)

RCH	R01	R02	R03	
Channel	CH101	CH101	CH101	CH101
Tag No.				
Tag Comment				
Mode	INST	AVE	SUM	SUM
Unit	V	V	V	V
1998/12/01 00:00	INST/AVE/SUM	0.3900	0.3834	20802.5486
	MIN/TOTAL		0.3669	20802.5486
	MAX		0.4025	
1998/11/30 17:00	0.3806	0.3818	1474.6093	
1998/11/30 18:00	0.3890	0.3826	2754.4033	
1998/11/30 19:00	0.3747	0.3832	2759.0441	

Ready NUM

Report time

Report ending time

Opening report files for display

For details see Section 6.2, "Opening Files for Display."

Converting report data into Excel/ASCII/Lotus 1-2-3 formats

Report file data can be converted into Excel/ASCII/Lotus 1-2-3 formats while the report file is on display.

- 1 From the menubar select Convert menu, and select To ASCII, To Lotus, or To Excel to open each dialog box.
- 2 Select Vert.CH or Hor.CH for Output format in each dialog box.

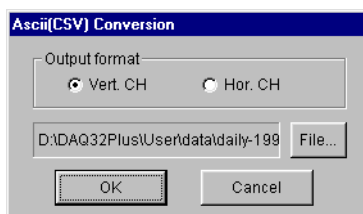

- 3 To change the file name or saving destination of the converted file, click the File button to open the Save As dialog box, select where to save the file, enter a file name, select the type. Click OK to return to Conversion dialog box.

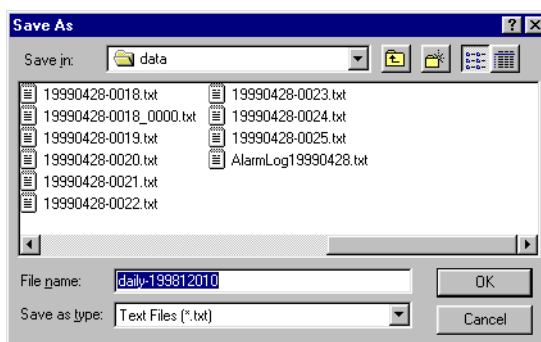

- 4 Click OK in the Conversion dialog box to close it. The data will be converted to the selected format and saved as a new file.

Note

- The file extension of the converted file is automatically changed to the following format names, to distinguish it from the original file: Excel conversions (possible for version 4.0 or higher) get the extension "xls", ASCII files "txt", and Lotus (possible for version 2.0 or higher) files get the extension "wjl2."
- For Lotus 1-2-3 and Excel there is a limit to the data that can be read. When the memory of your PC is not sufficient, data may not be read even though the data limit is not exceeded.
- Files with converted formats are saved to the same directory as the original.
- Do not select external media like floppy disk to save data.
- Do not select save data in a root directory.
- Make sure there is enough memory before saving data.

Printing out the active report file

- 1 Select Vertical channel format or Horizontal channel format.
Refer to Section 6.17, "Printing Measurement Data."

7.1 Operating Procedures for the Tag Editor

Starting the tag editor

After selecting the project, click the tag editor start button from the launcher software or right-click the launcher icon on the task bar and select Start Tag editor.

The tag editing dialog box opens.

Displayed information

The dialog box displays a list of Tag Nos. and the initial values of Tag Comments or the Tag Nos. and Tag Comments that were saved previously. The tag data (Tag Nos. or Tag Comments) can also be received from the DC100 or DR.

Setup data save button

Send Tag No. button

Receive Tag No. button

Send Tag Comment button

Receive Tag Comment button

Copy button

Paste button

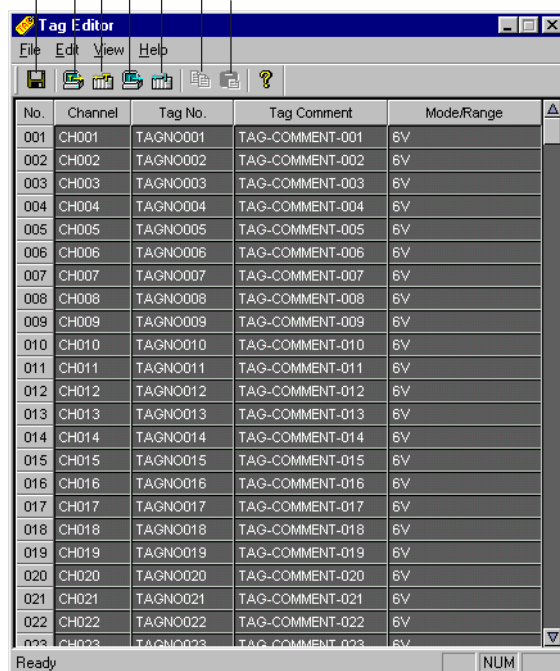

Note

The Mode/Range column will not display correct information unless the PC and the DC100 or DR had firmly established communication at program startup.

7.2 Receiving Tag Data

Reads in the tag data that are set by the DR or DC100.

Select whether to receive the tag data as Tag Nos. or Tag Comments.

- 1 Click the Receive Tag No. button or the Receive Tag Comment button on the toolbar or select File > Receive from the menu and select Receive Tag No. or Receive Tag Comment.

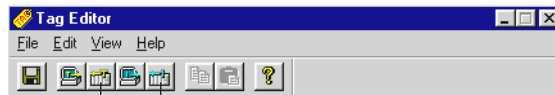

Tag data are received as Tag Nos. if you select Receive Tag No.

Tag data are received as Tag Comments if you select Receive Tag Comment.

Note

- The tags from the DC100 are eight alphanumeric characters or less in length.
- The tags from the DR are 16 alphanumeric characters or less in length. If the data are received as tag No., the first eight characters are read in.
- The Tag No., Tag Comment, and Mode/Range columns for the channels that do not have tag data will show blanks.
- °, Ω, and ∅ are replaced with spaces. μ and ε are replaced with 'u' and 'e,' respectively.
- [deg] was unchanged.

7.3 Setting Tag Nos. and Tag Comments

- 1 On the Tag Editor screen, clicking the area showing the name of the Tag No. or Tag Comment displays an edit box.

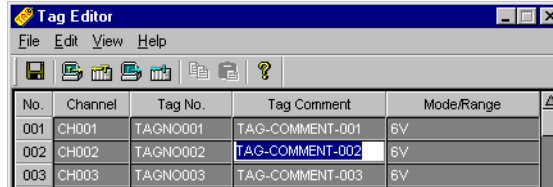

- 2 Enter the Tag No. or Tag Comment in the edit box.
Tag Nos. can be up to 8 characters and Tag Comments can be up to 16. If you are going to write to the DC100 or DR, use only the following characters. All other characters (including double-byte characters) will be replaced with some other appropriate characters such as spaces.
0 to 9 A to Z : # % & () * + - . /

Copying and pasting Tag Nos. and Tag Comments

Copies the Tag No. and Tag Comment of one channel to another channel.

- 1 On the Tag Editor screen, click the number at the No. column to select the copy source.
- 2 Click the copy button on the toolbar or select Copy from the Edit menu.

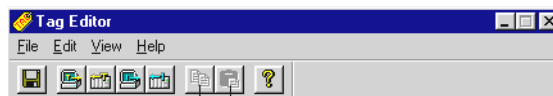

- 3 Click or drag the number(s) at the No. column to select the copy destination.
- 4 Click the paste button on the toolbar or select Paste from the Edit menu.

Sorting

The list can be sorted in alphabetical order by channel numbers, Tag Nos., Tag Comments, and mode/range.

- 1 Click the Channel, Tag No., Tag Comment, or Mode/Range on the Tag Editor screen, or point to Sort by from the View menu and select the sorting type, Channel numbers, Tag Nos., Tag Comments, or Mode/Range.

Note

Selecting the same sorting type consecutively switches the ascending/descending order.

7.4 Saving Tag Data to a Tag File, Writing Tag Data to DC100/DR

Saving the modified tag data to a file

- 1 Click the save button on the toolbar or click Save from the File menu.



Save button

Note

There is only one tag file. Thus, the new tag data will overwrite the previous tag file.

Writing the new tags and tag IDs to the DC100, DR

- 1 Select either to send the Tag Nos. or Tag Comments in the tag data file. Click the Send Tag No. button or Send Tag Comment button on the toolbar or point to Send from the File menu and select Send Tag No. or Send Tag Comment.

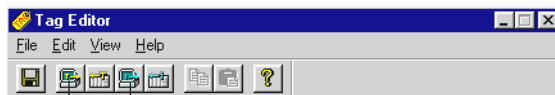

Send Tag Comment button
Send Tag No. button

The Tag Nos. or Tag Comments will be set as tags for the DC100 and DR.

Note

- The first eight characters will be set as tags if you send Tag Comments to the DC100.
- The DR and DC100 consider all characters besides the following characters to be spaces.
Numbers
Upper and Lower case alphabet
% & () * + - . /

8.1 Operating Procedures on the Calibration Screen

Displaying the calibration screen

Calibration is done using the Software Configurator.

After selecting the project, click the Software Configurator from the launcher software or right-click the launcher icon on the task bar and select Start Software Configurator.

The Software Configurator starts.

Clicking the Calibration tab displays the calibration screen, below.

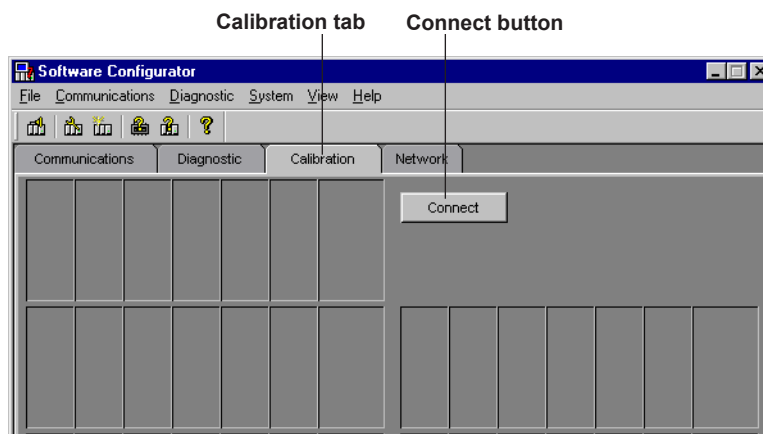

Calibration procedures

There are two ways to perform calibration.

- Auto: Apply the specified voltage to the terminal displayed on the screen, and calibrate all channels based on that input signal.
- Manual: Calibrate by setting a calibration value for each channel.

8.2 Auto Calibration

Operating Procedures

- 1 Click the connect button on the calibration screen. The DA100, DC100, or DR system that is connected will be displayed.

Module that does not need to be calibrated

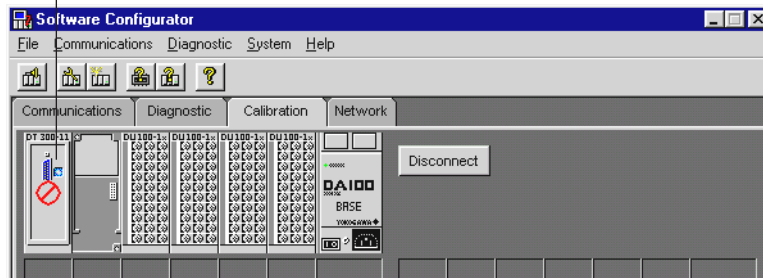

⊘ marks are displayed for modules that do not need to be calibrated.

- 2 Clicking the module to be calibrated displays the calibration dialog box.

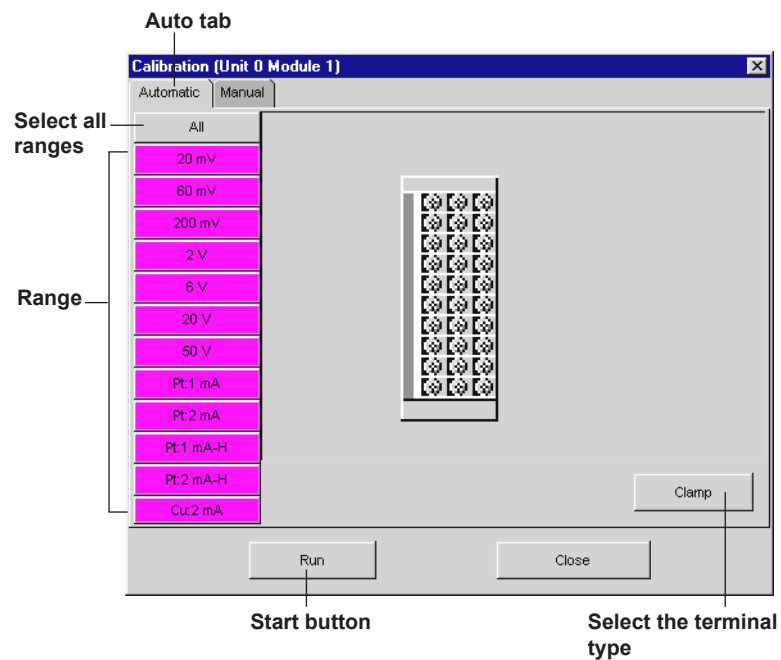

- 3 Click the Auto tab to display the auto calibration screen.
- 4 Clicking the range to be calibrated shows the selected range in red. To calibrate all ranges click All.

- Clicking the Start button displays the connection type of the terminal and the input value in an illustration and a message for confirming the connection and input.

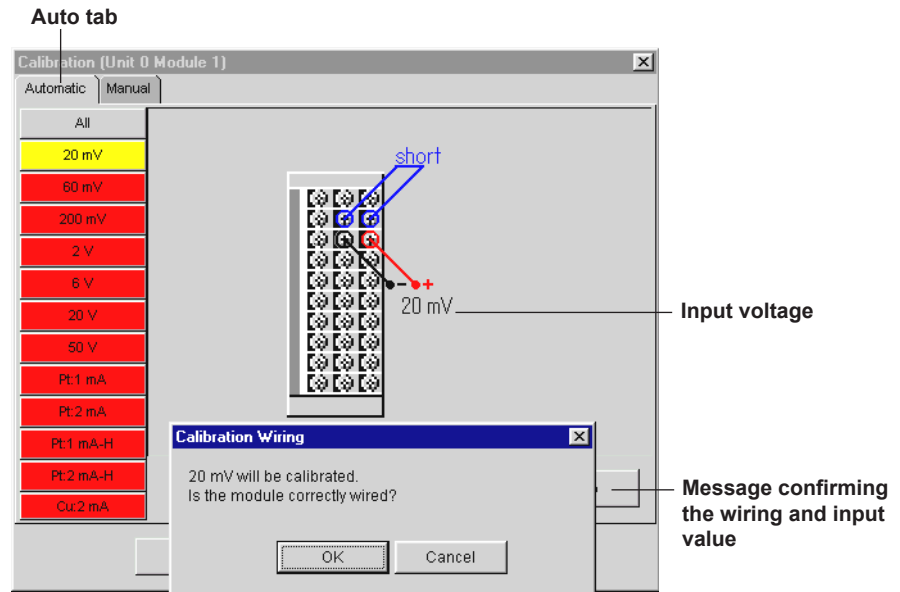

- Wire the terminals of the DA100, DC100, and DR as shown in the displayed illustration and apply the specified voltage to the specified terminal.
- If you had selected multiple ranges to be calibrated, the wiring and the input value for the next range is shown in an illustration, just like in step 5, along with the confirming message when the OK button is clicked.
- After confirming the wiring and the input for all ranges according to steps 5 and 6, a final confirming message is displayed to fix the calibration value. Clicking the OK button displays a message notifying that the calibration value has been fixed.
- Clicking the OK button terminates the calibration. To calibrate another module, click the Close button and repeat from step 2. OK is displayed for the modules that have completed the calibration.

8.3 Manual Calibration

Operating Procedures

- 1 Click the connect button on the calibration screen. The DA100, DC100, or DR system that is connected is displayed.
- 2 Clicking the module to be calibrated displays a calibration dialog box.
- 3 Click the Manual tab to display the manual calibration screen.

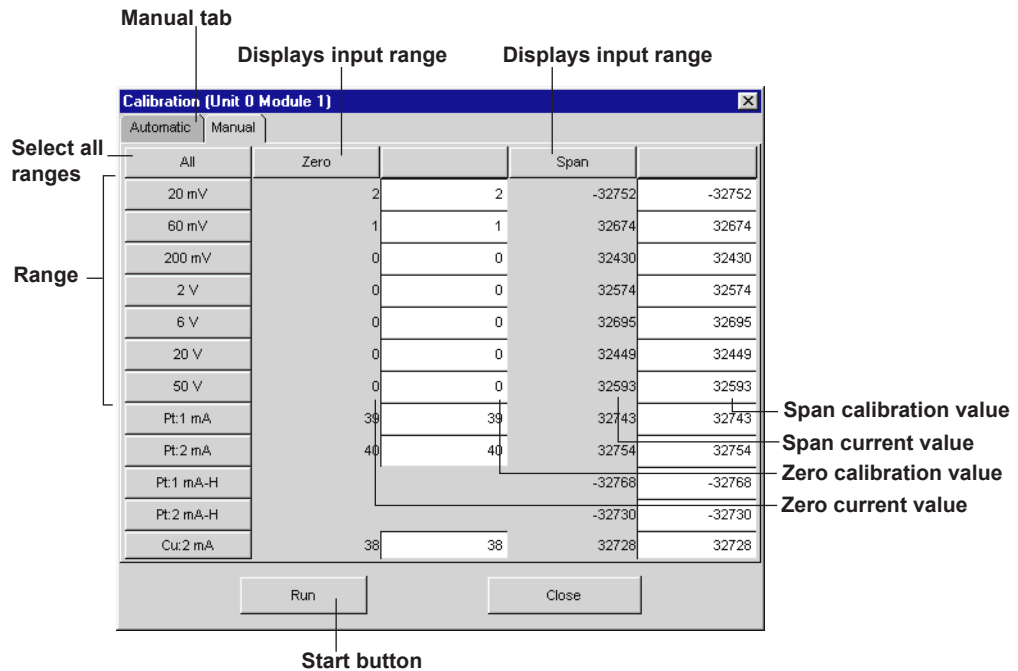

- 4 Clicking the range to be calibrated shows the selected range in red. To calibrate all ranges click All.
- 5 Set the calibration values for Zero and Span, individually. Clicking the Zero or Span display area shows the setting range.
- 6 Clicking the Start button displays a message for writing the calibration value.
- 7 Clicking the OK button displays a final message for fixing the calibration value.
- 8 Clicking the OK button displays a message notifying that the calibration value has been fixed.
- 9 Clicking the OK button terminates the calibration. To calibrate another module, click the Close button and repeat from step 2. OK is displayed for the modules that have completed the calibration.

Explanation

Perform the calibration in the following sequence:

Universal Input Module

20mV ZERO > 20mV SPAN > 60mV ZERO > 60mV SPAN > 200mV ZERO
> 200mV SPAN > 2V ZERO > 2V SPAN > 6V ZERO > 6V SPAN
> 20V ZERO > 20V SPAN > 50V ZERO > 50V SPAN > Pt:1mA ZERO
> Pt:1mA SPAN > Pt:2mA ZERO > Pt:2mA SPAN > Pt:1mA-H SPAN
> Pt:2mA-H SPAN > Cu:2mA ZERO > Cu:2mA SPAN

DCV/TC/DI Input Module

Same sequence as the Universal Input Module except for the RTD (resistance temperature detector).

mA Input Module

20mA ZERO > 20mA SPAN

Strain Input Module

2k ZERO > 2k SPAN > 20k ZERO > 20k SPAN > 200k ZERO > 200k SPAN

Digital Module

60mV ZERO > 60mV SPAN > 6V ZERO > 6V SPAN

Adjustable range/Error conditions/Display

The adjustable range is from -32768 to 32767.

However, 16384, -16384, 16385, and -16383 are excluded.

Note

The adjustable range is as described above. However, if the following conditions are not met, the module is considered erroneous.

- ZERO calibration value: -3277 to 3277. The ideal value is 0.
- SPAN calibration value: 29491 to -29491. The ideal value is -32768.
19000 to 21000 for the strain input module. The ideal value is 20000.

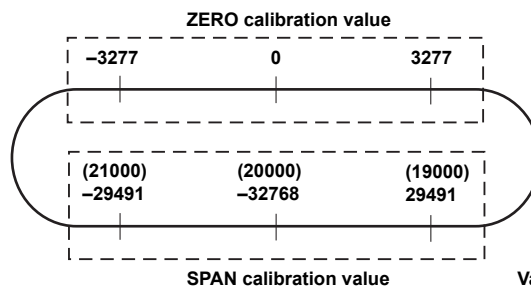

Values in parenthesis are for strain input modules.

8.4 Calibrating the Transmission Output Module (DA, DC only)

Calibration Method

The following two methods may be used for calibration:

- Calibrating while checking the values with instruments such as a digital multimeter.
- Calibrating by using a previously determined value.

Note

When calibrating with a previously determined value, the DA100 or DC100 may not be able to recognize the transmission output module depending on which calibration values are set.

Procedure

Calibrate while Confirming the Output Value

Connect the transmission output terminal to be calibrated to a DMM which satisfies the specifications below.

Specification	Recommended Device
Accuracy	HP3458A
DCV: +/- (0.01% of rdg. +10µV)	
DCA: +/- (0.01% of rdg. +0.5µA)	

1. Click the connection button in the calibration screen. The system of the DA100 or DC100 that is connected is displayed.

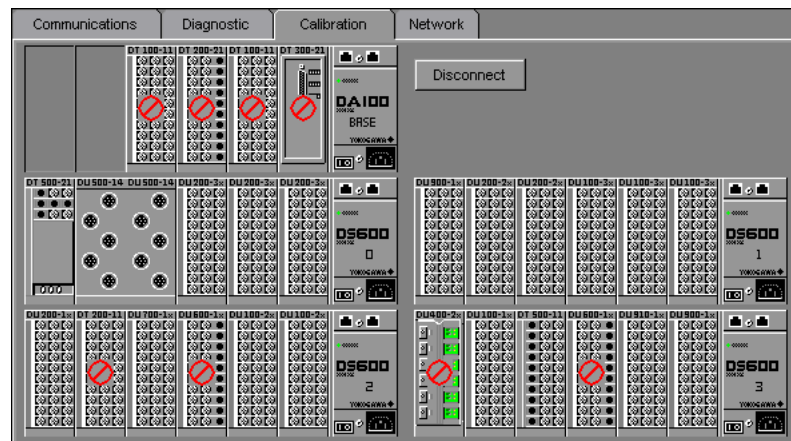

A[⊗] mark is displayed for modules that do not require calibrating.

8.4 Calibrating the Transmission Output Module (DA, DC only)

- When you click the module to be calibrated, the calibration dialog box appears.

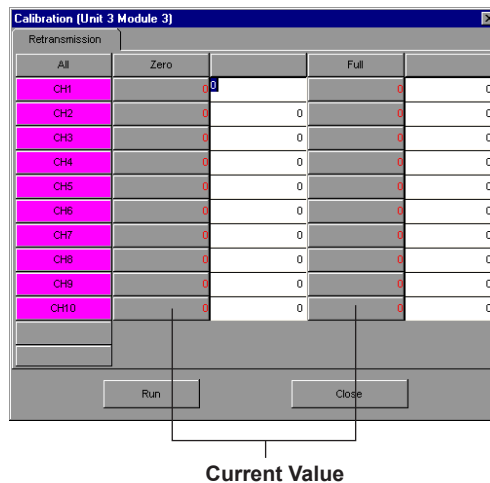

- Click the button (in the Zero or FULL column) displaying the current value of the output terminal to be calibrated. The calibration value setting screen appears.

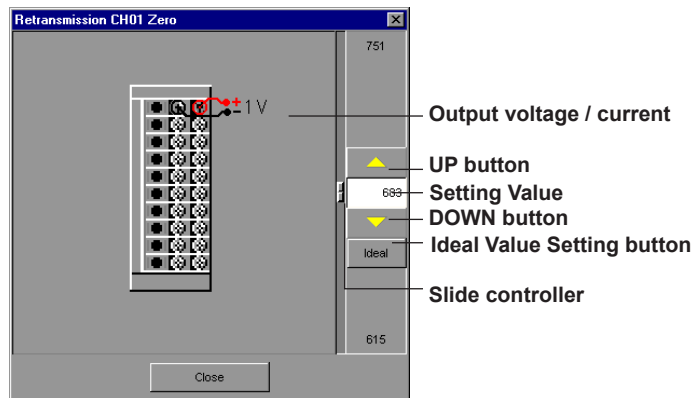

- Set the calibration value with the slice controller or by clicking the UP/DOWN buttons. The voltage and current corresponding to the set calibration value is output from the terminal displayed in the onscreen illustration. Click the ideal value button to quickly select the ideal value setting.
- When you click the [Close] button, a message appears confirming whether you want to save the current calibration setting values. If you click [OK], the calibration value settings confirmation message appears.
- Click [OK] again to complete the calibration procedure. If you wish to calibrate another terminal, repeat the procedure from step 3. [OK] is displayed on modules for which calibration has been completed. When you want to calibrate another module, click the [Close] button, and repeat the procedure from step 2.

8.4 Calibrating the Transmission Output Module (DA, DC only)

Set the Calibration Value to a Previously Decided Value

1. Click the connection button in the calibration screen. The system of connected DA100s is displayed. A [Ø] mark is displayed on modules that don't require calibration.
2. When you click a module to be calibrated, the calibration dialog box appears.

All	Zero	Full
CH1	0	0
CH2	0	0
CH3	0	0
CH4	0	0
CH5	0	0
CH6	0	0
CH7	0	0
CH8	0	0
CH9	0	0
CH10	0	0

3. Click a terminal to be calibrated (CH1, CH2, etc.) the selected terminal is displayed in red. When calibrating the entire range, click [All].
4. Enter the calibration value for each Zero and FULL. When you click the [Zero] and [FULL] buttons, the setting range is displayed.
5. When you click the [start] button, a message appears to confirm that you wish to save the calibration values.
6. When you click [OK], a message appears to reconfirm that you wish to save the current calibration values.
7. When you click [OK], a report appears telling you that you calibration values were accepted.
8. Click [OK] to conclude calibration. When calibrating a separate module, click the [Close] button, and repeat the procedure from step 2. [OK] is displayed on modules for which calibrating has been completed.

8.5 Saving Calibration Data

Calibration data can be saved as an ASCII file.

- 1 Click the connect button on the calibration screen. The DA100, DC100, or DR system that is connected is displayed.
- 2 Select File > Save as...to display a Save As dialog box.
- 3 Enter a file name in the text box and Click Save.

9.1 Operating the Remote Monitor

Starting the Remote Monitor

Follow one of the steps below:

For DAQ 32 Plus

- After selecting the desired project, click the Remote Monitor button on the Launcher, or right click the Launcher icon on the taskbar and select Remote Monitor.
- Select Program > YOKOGAWA DAQWORX > DAQ 32 Plus > Remote Monitor from the Windows Start menu.

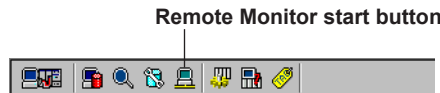

For DAQ 32 Plus Client Package

Select Program > YOKOGAWA DAQWORX > DAQ 32 Plus Client > Remote Monitor from the Windows Start menu.

The Remote Monitor window opens.

Functions

The Remote Monitor function is used to observe data with a personal computer connected to the host through a network. A monitor server is required for the host. (Please refer to Section 5.15, “Using the Monitor Server”).

You can display an Alarm Monitor, Trend Monitor, Color Graph Monitor, Digital Monitor, Meter Monitor, and Circular Monitor. The functions of each monitor are equal to those in Logger software. Furthermore, cursors can be used in Alarm Log display. (Please refer to Using cursors for Alarm Log display on page 9-7.)

Waveform display settings are also equal to Logger software.

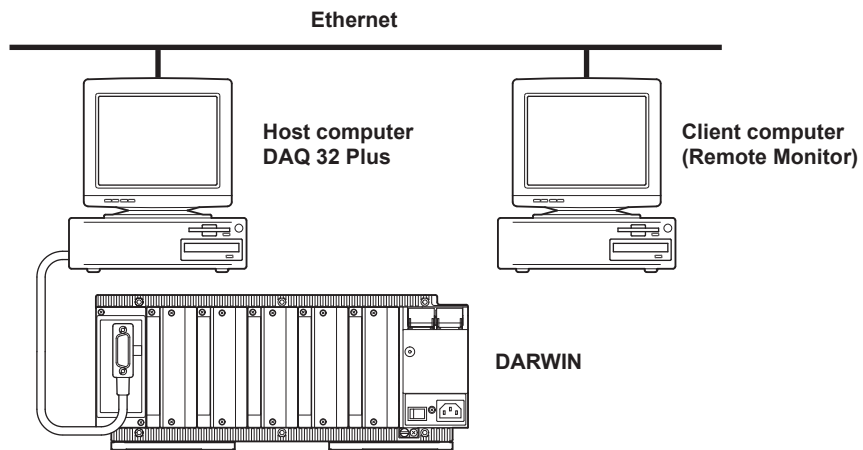

9.1 Operating the Remote Monitor

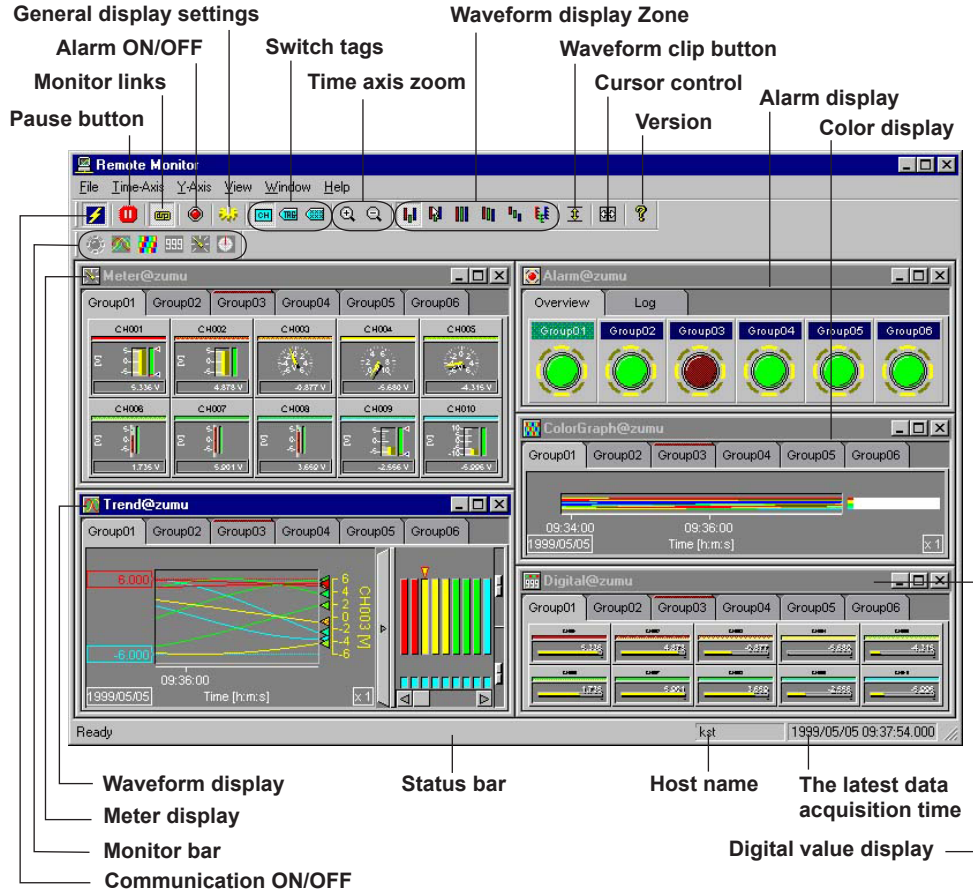

Tool-, Monitor-, and Status Bar display

To display or hide the Tool-, Monitor-, and Status Bar, select from the menubar View > and the desired bar.

Status bar display

When the Remote Monitor is connected to the host, the name of the host and the latest updated time will be displayed on the Status bar.

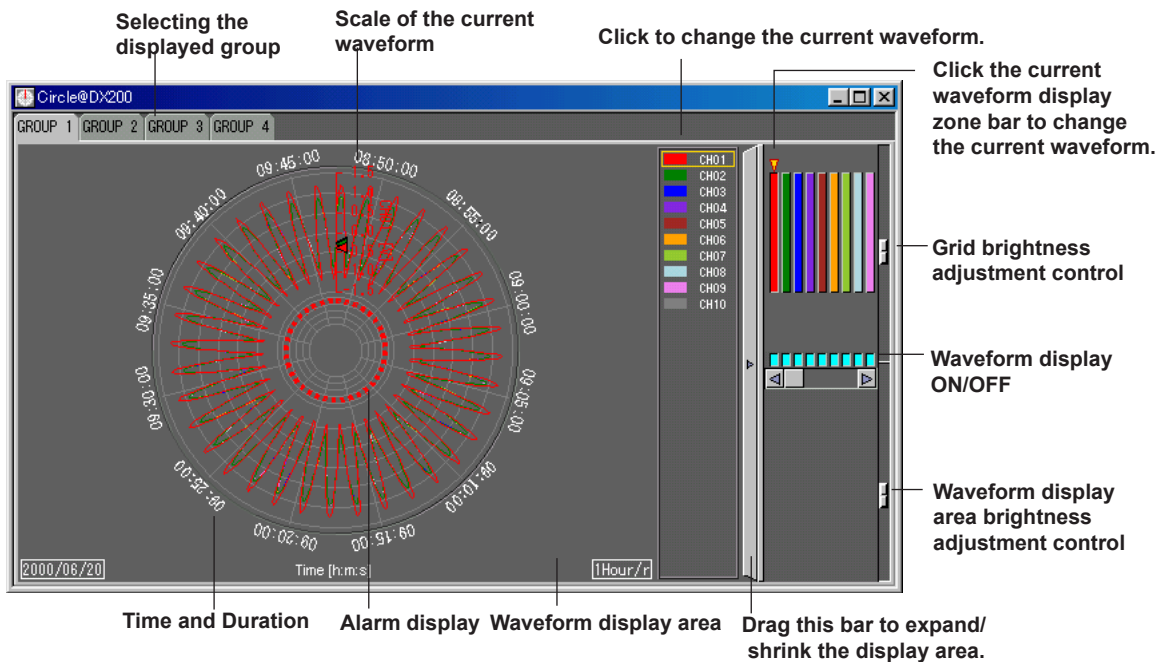

Procedure for Circular Monitor

The DAQ can display 1800 measurement data points. The waveform may not go around the entire screen depending on the recording period set by the logger function of the host, and the display time of the circular monitor.

Setting the Time Axis

1. Choose a time of 1 hr., 2 hrs., 6 hrs., 12 hrs., 16 hrs., 1 day, 2 days, 1 week, 2 weeks, or 4 weeks from the [Time Axis].

Alarm Display Placement

You can set the alarm display inside or outside of the waveform.

1. Change the settings from [View] to [Alarm Inside] or [Alarm Outside]. The other operations are the same as ones like the trend display.

9.2 Connecting the Host and Saving Connection Conditions

When the host PC gets connected for the first time please make the below three settings.

- Connecting host name.
- Port number.
- Step number (the amount of data acquired from the host per connection).

If connection conditions have already been set for a file just open and connect it.

Note

- Connection may get cut off because of circuit problems. Reconnect it.
- If connection is not possible it is likely that the host name isn't recognized. Register the host name in the host file.
- To use the Monitor Server or Remote Monitor, your PC must have an Ethernet card, and the Windows TCP/IP service.

Setting connection conditions

- 1 Select from the Remote Monitor menubar File > New.
- 2 Select File > Connect, or File > Configuration... The Connect Settings dialog box will appear.

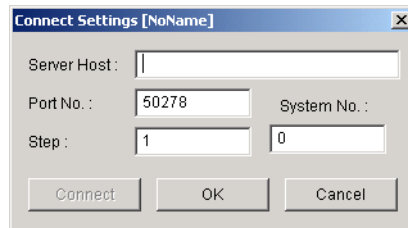

- 3 Enter the Host Name, Port number, System No., and Step number in the textboxes.

You must enter 0 for the system number.

Note

- The port number must match the port number set for the remote server.
- The initial Port No. value is 50278.
- The initial Step value is 1.

Connecting

- 4 After all the correct settings are made click the Connect button in the Connect Settings dialog box to connect the host. Click OK in the Connect Settings dialog box to save the setting data and to close the dialog box, or Cancel to close the dialog box without saving settings.

Note

If you clicked OK in step four, it is possible to open the connection by selecting File > Connect, or by clicking the Connect/Disconnect button on the toolbar.

Saving connection conditions

- 5 Select from the Remote Monitor menubar File > Save As... . Enter a file name, select the desired directory and click the Save button.

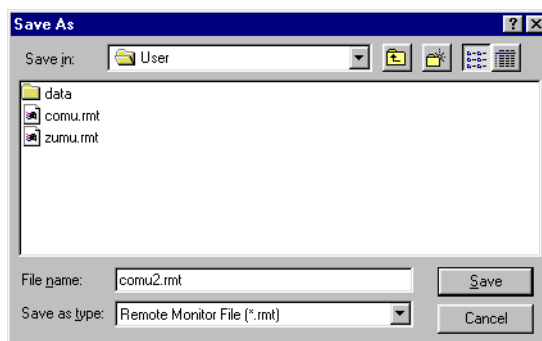

Note

Waveform display settings will also be saved when you save the connection conditions.

Connecting with earlier set connection conditions.

Connect the host PC in one of the following two ways to open earlier set connection conditions:

- Click File and select a file from the pull-down menu (if no conditions have been saved earlier, only the word "Latest File" will appear).
- Click File > Open, and select a file from the dialog box.

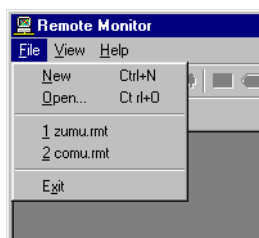

9.3 Group Settings/Displaying and Changing the Monitor/Using Cursors

Making group settings

Group settings are made as described for Logger software, explained in Section 5.3, “Group Settings.”

Displaying waveforms on a monitor and changing the monitor screen

Monitor screens are displayed inside the Remote Monitor window. The content of the displayed menubar of the Remote Monitor may differ for each monitor screen.

On the toolbar all tools are displayed, however, only the buttons related to the selected monitor screen are active.

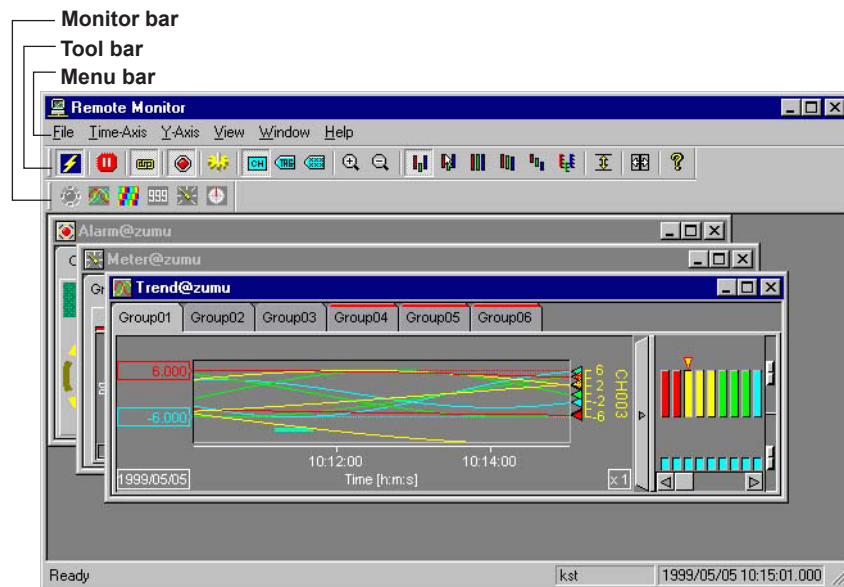

- Displaying Monitor screens
To display Monitor screens click the button for the Alarm, Trend, Color Graph, Numeric, or Meter Monitor on the Monitor bar, or select Window from the menubar, and choose the desired monitor.

Note

- For one connection it is possible to open the following amount of Monitor screens:
 - Alarm Monitor: 1 screen
 - Trend Monitor: 4 or less screens
 - Color Graph Monitor: 4 or less screens
 - Numeric Monitor: 4 or less screens
 - Meter Monitor: 4 or less screens
 - Circular Monitor: 4 or less screensNote that your PC performance may get slower if many screens are opened simultaneously.
- Select Window > Tile, or Cascade to change the Monitor screen display order.

9.3 Group Settings/Displaying and Changing the Monitor/Using Cursors

Except for the below points, operation is equal to Logger software (see Section 5.4, “Displaying Waveforms on the Monitor,” or Section 5.6, “Changing Monitor Display”).

- Using cursors for Alarm Log display.
If data renewal for waveform display is being paused (see Section 9.4), it is possible to assign cursors on the Alarm Log screen of the Alarm Monitor, as shown in below illustration.
Click the first data for cursor A, and drag it to the desired point for cursor B. The cursors will also appear in the Color Graph and Trend monitors, if they are linked.

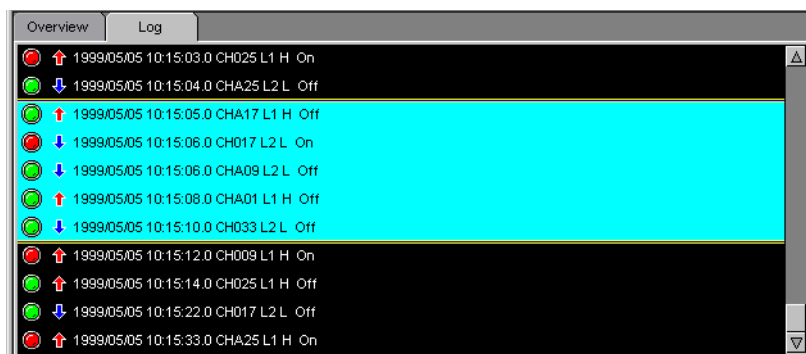

Cursor operation

Cursor operation is equal to Logger software (see Section 5.7, “Cursor Measurement”).

9.4 Pausing or Exiting Monitor Display

Pausing Monitor Display

When monitor display is paused, data acquisition will continue. The data will be displayed if you reopen monitor display.

- 1 To pause monitor display, click the Pause button of the desired display, or select File > Pause.

Note that only the display of the monitor screens that are displayed will be paused.

Pause button

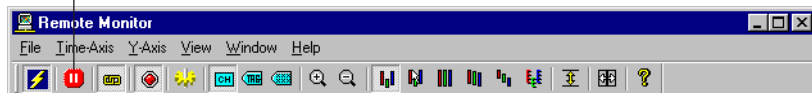

- 2 To restart a paused monitor screen again click the Pause button, or select File > Pause.

Closing Monitor Display

To close a monitor screen click the cross in the right top corner, or click the monitor icon in the left top corner and select Close (Ctrl+F4).

Monitor icon

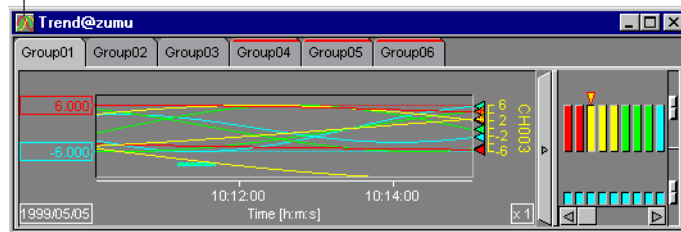

Note

If the host is successfully connected at least one monitor screen will be displayed. To close the last screen you will first be asked to confirm whether or not you wish to cancel communication. Click OK to cancel communication, then close the monitor screen.

Exiting Monitor Display

To exit monitor display you will have to cut off communication.

- 1 Click the Communication icon on the toolbar, select File > Exit, or click the Remote Monitor icon and select Close (Alt+F4).
- 2 To close the last screen you will first be asked to confirm whether or not you wish to Cancel communication. Click OK to cancel communication, then close the Remote Monitor.

Remote Monitor icon

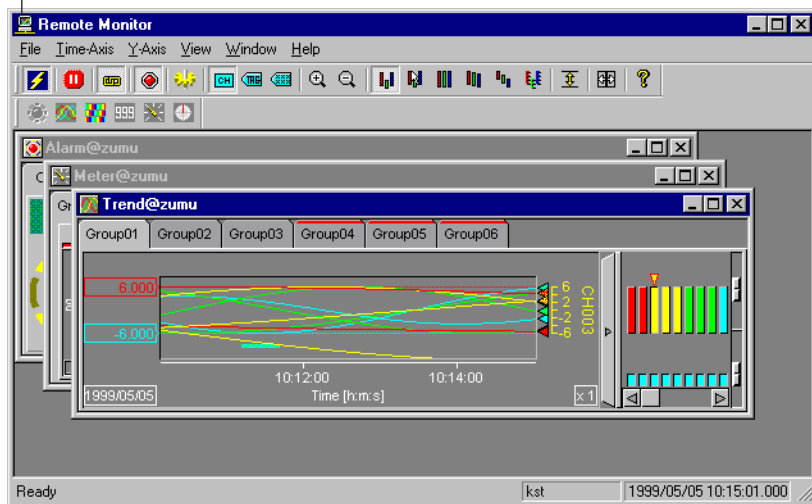

10.1 Operating the File Utility software

Starting File Utility software

For DAQ 32 Plus

Follow one of the steps below

- After selecting the desired project, click the Remote Monitor button on the Launcher, or right click the Launcher icon on the taskbar and select File Utility.
- Select Program > YOKOGAWA DAQWORX > DAQ 32 Plus > File Utility from the Windows Start menu.

For DAQ 32 Plus Client Package

Select Program > YOKOGAWA DAQWORX > DAQ 32 Plus Client > File Utility from the Windows Start menu.

The File Utility window opens.

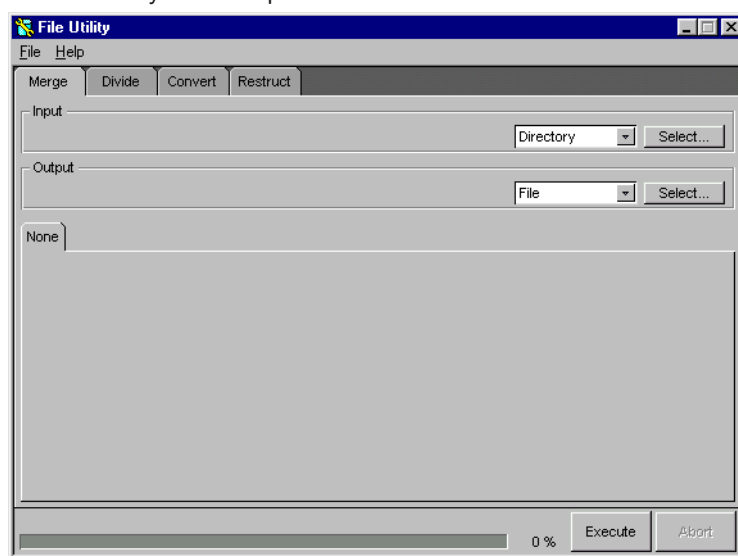

Functions

File Utility has the following four operation functions:

- 1** Merging Files (Merge): To merge continuous files into a new file.
- 2** Dividing Files (Divide): To divide one file into multiple files.
- 3** Converting Files (Convert): To convert data into Excel, ASCII, and Lotus 1-2-3 formats.
- 4** Restructuring Files (Restruct): To merge continuous files into a new file and divide them with new conditions.

The operation functions apply only to files with below extensions. For details on each operation function and file limitations see the respective sections in this chapter.

.daq :Data files of DAQ 32 R9 or later/DAQ 32 Plus R9 or later created with Logger software.

.bfd, Y** : Data files created with Logger software before R9.

.dat, .das : Data files created with DR/DC100.

.rbi : Report files created with DR/DC100 with report options, and report files acquired with Logger software.

.daq :Data files being merged or divided with File Utility.

Set Input file/directory (original file/directory) and Output file/directory (where to save) and execute. If a directory is selected, all files in the directory will be applied to the functions. Process will be displayed on the Status bar. Merge, Divide, Convert, Restruct functions will not affect the original files.

10.2 Merging Measurement Data Files

This section explains how to merge data files with daq extension into a new file. The extension for the new file will also be “daq.”

The following two file types can be merged:

- Files acquired with Logger software that are divided by a fixed File Length. (Check Set File Length in the Logging Configuration dialog box).
- Files divided with File Utility software (not including files with Division type “Single Fixed”, or “Division Point” with Interval setting “Fixed Time of Day”).

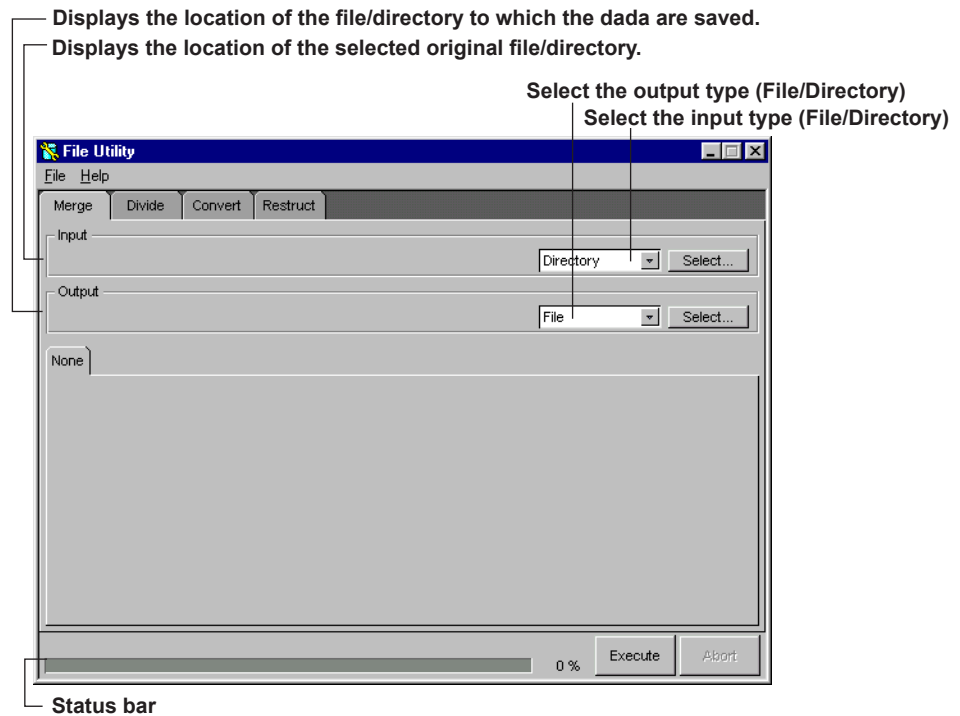

- 1 Click the Merge tab to display the Merge settings.

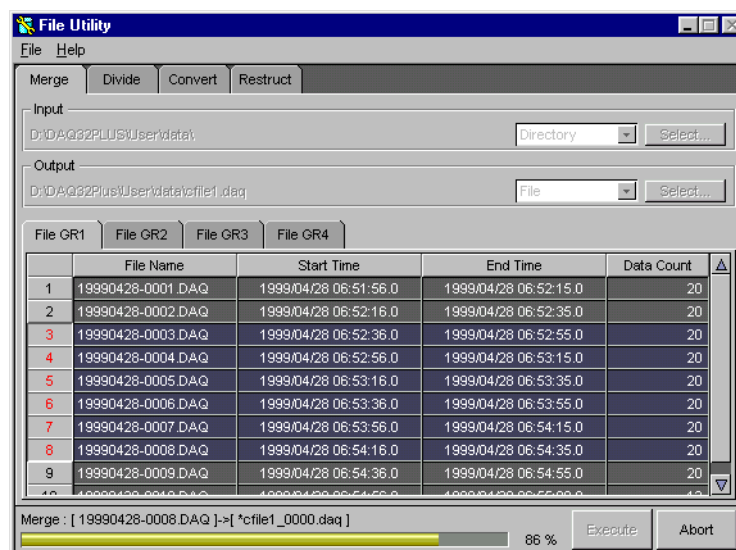

Selecting files to merge

- 2 To specify the original files you want to merge, first click the Select... button in the Input frame. In the dialog box that opens select the directory with the files you want to merge.
- 3 If there are different measurement data groups in the directory Group tabs will be displayed. Files within the same group can be merged. Click the Desired Group tab.
- 4 Select the files to be merged by dragging the numbers' column on the left side of the file list. In the illustration example on page 10-2 files 3 to 8 of Group 1 are selected for merging.

Note

- If you don't select any specific files, all the files within the group will be merged.
- To undo a selection, drag again.

Selecting the file to save merged data to

- 5 To select the files you want to save the merged data to, first click the Select... button in the Output frame. In the dialog box that opens select where to save the merged data. Input a file name in the File name textbox, and click OK.

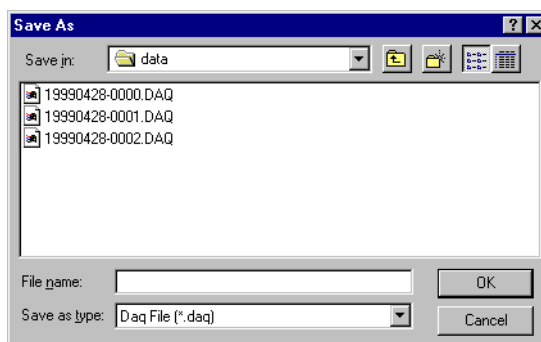

Note

- Do not select external media like floppy disk to save data.
- Do not save data in a root directory.
- Make sure there is enough memory before saving data.

- 6 Click Execute to merge, and Abort to cancel the settings.

Note

Sometimes it may take time to abort.

10.3 Dividing Measurement Data Files

Files with “daq”, “bfd”, “y**”, “dat”, and “das” extensions can be divided into multiple files. The output file name will automatically get extension “daq.” Files can be divided in three different ways (division types):

- **Division Point**

The original file is divided into multiple files by creating intervals “per Day” or “per Hour.” For the “per Day” interval setting, an additional “Fixed Time of Day” division is possible.

- **Interval Length**

The original file is divided into multiple files with a fixed data count or time count used as interval.

- **Single Fixed**

A fixed file part is selected between certain data numbers or between a certain time span to create a single new file.

Note

The last file of files divided with Division Point or Interval Length will be shorter if the data count does not fit exactly.

- 1 Click the Divide tab to display the Divide settings.

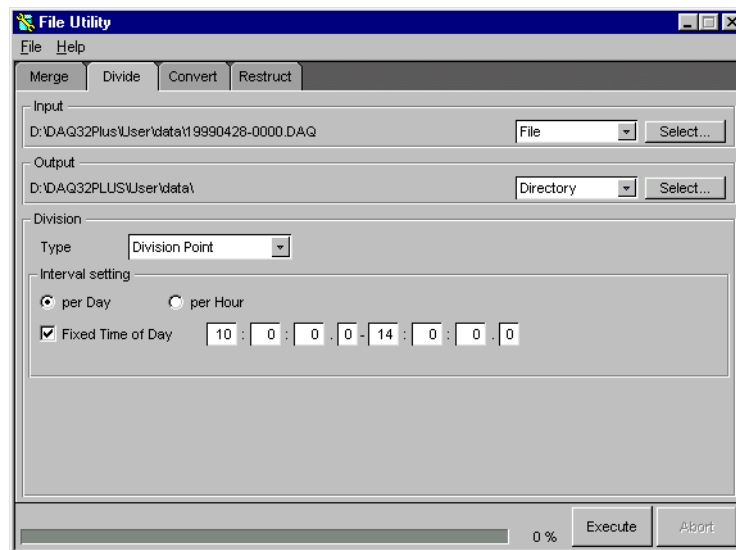

- 2 Specify the original file in the Input frame. Select File or Directory in the Input Type listbox.

Note

When Directory is selected, all files in the directory that apply to the division conditions will be divided.

- 3 Click the Select button and in the dialog box that opens select the desired file or directory.

- 4 In the Output frame select the directory to save the divided files to. Click the Select button and choose a directory in the dialog box.

Note

-
- Do not select external media like floppy disk to save data.
 - Do not save data in a root directory.
 - Make sure there is enough memory before saving data.
-

Division Point settings

- 5 Select Division Point in the Division Type listbox.
- Per Day settings
 - 6 Click the “per Day” radio button in the Interval Setting frame.
 - 7 Click Execute to divide and Abort to cancel.
 - Additional Fixed Time of Day settings
 - 6 Click the “per Day” radio button in the Interval Setting frame. Check Fixed Time of Day.
 - 7 Specify the interval range by fixed time.

(In the illustration example on page 10-4 every day data measured from 10:00 to 14:00 will be output.)
 - 8 Click Execute to divide and Abort to cancel the settings.

Note

A fixed time from, for example, 23:00 to 1:00 the next day, is also possible.

- Per Hour settings
 - 6 Click the “per Hour” radio button in the Interval Setting frame.
 - 7 Click Execute to divide and Abort to cancel.

Interval Length settings

- 5 Select Interval Length in the Division Type listbox.

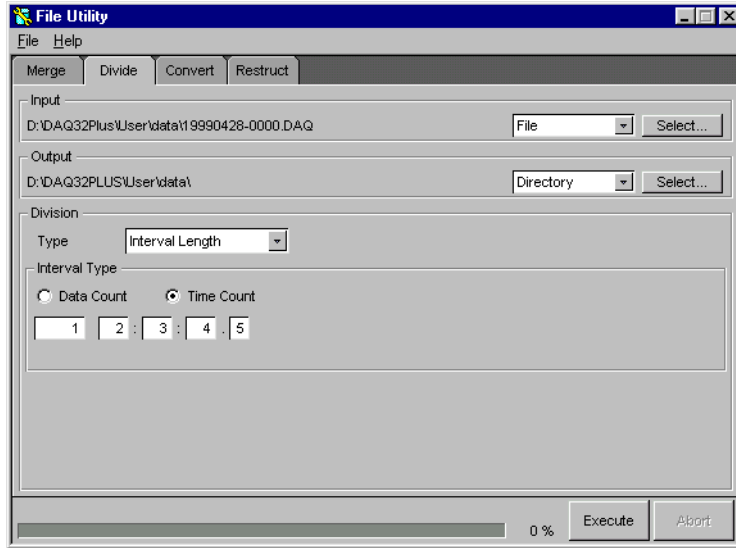

- When setting Data Count for Interval Length
 - 6 Click the Data Count radio button in the Interval Type frame.
 - 7 Enter a data count in the textbox.
 - 8 Click Execute to divide and Abort to cancel the setting.
- When setting Time Count for Interval Length
 - 6 Click the radio button of Time Count in the Interval Type frame.
 - 7 Enter a time count in the text box. In the illustration example the interval length for each file division will be 1 day, 2 hours, 3 minutes and 4.5 seconds.
 - 8 Click Execute to divide and Abort to cancel the setting.

Single Fixed settings

- 5 Select Single fixed in the Division Type listbox.

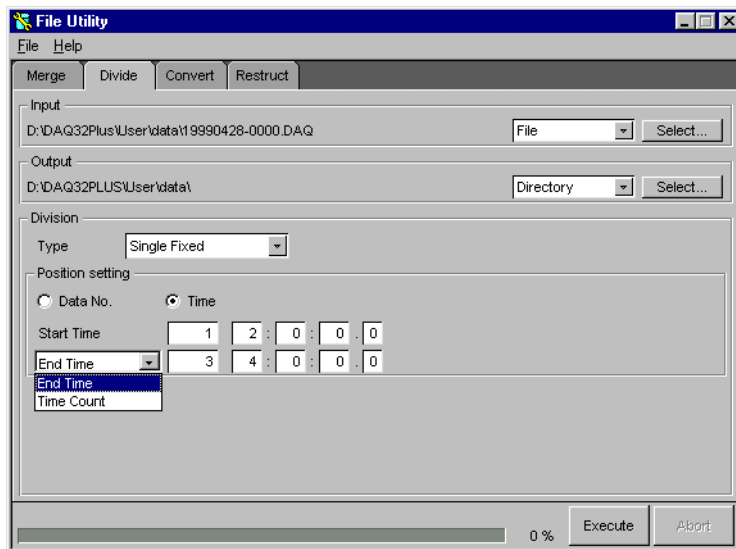

- When using Data No. as Position Setting
 - 6 Click the Data No. radio button in the Position Setting frame.
 - 7 Enter start data No. in the text box.
 - 8 Select End Data No. or Data Count in the listbox and enter end data No. or data count in the text box.
 - 9 Click Execute to divide and Abort to cancel.

- When using Time as Position Setting
 - 6 Click the Time radio button in the Position Setting frame.
 - 7 Enter the start time in the text boxes.
 - 8 Select End Time or Time Count in the listbox and enter either the end time or the time count after the start time in the text box.
 - 9 Click Execute to divide and Abort to cancel the settings.

Note

If the position you specified does not exist in the original file, no new files will be created.
It may take time to abort the settings.

Output file names

The extension for output files will automatically be set to “daq.”

Division Point/Interval Length Type file names

A follow-up number will be added behind the original file name for distinction.

For example

file name_0000.daq

(0000 being the follow-up number)

Single Fixed Type file names

Although only one file will be saved with Single Fixed type, a follow-up number will be added behind the original file name if there are already files with the same name in the output directory.

10.4 Converting the Data Format

This section explains how to convert data files with extensions “daq”, “bfd”, “y**”, “dat”, and “das”, and report files with extension “rbi” into Excel/ASCII/Lotus 1-2-3 formats.

- 1 Click the Convert tab to display the Convert settings.

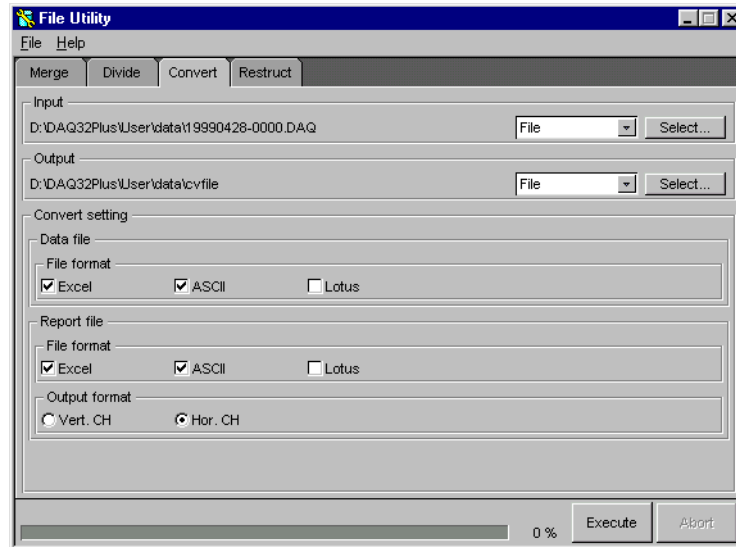

- 2 Select the file you want to convert in the Input frame. Select File or Directory in the Input Type listbox.

Note

When Directory is selected, all files in the directory with suitable conditions will be converted.

- 3 Click the Select button and select a file or directory in the dialog box.
- 4 In the Output frame select File or Directory to save the converted files to. (Select Directory if you selected Directory in the Input Type listbox.) Then click the Select button and choose a file or directory in the dialog box.

Note

If you select File (Directory) in the Input Type listbox but Directory (File) in the Output type listbox, the Input Type listbox will automatically be changed to the output type.

- 5 Click the Select button and select a file or directory in the dialog box.

Note

- Do not select external media like floppy disk to save data.
- Do not save data in a root directory.
- Make sure there is enough memory before saving data.

Convert settings

- 6 To convert data files check the desired format in the Data File format setting frame.

To convert report files check the desired format in the Report File format setting frame. For report files additionally select Vert.CH or Hor.CH in the Output format frame, to determine whether in the report Channel numbers are placed vertically or horizontally.

- 7 Click Execute to convert and Abort to cancel.

Note

- It is possible to convert a file to more than one file format simultaneously.
 - The file extension of converted files is automatically changed to the following format names, to distinguish it from the original file: Excel conversions (possible for version 4.0 or higher) get the extension "xls", ACSII files "txt", and Lotus 1-2-3 (possible for version 2.0 or higher) files get the extension "wj2."
 - For Lotus 1-2-3 and Excel there is a limit to the data that can be read. When the memory of your PC is not sufficient, data may not be read even though the data limit is not exceeded.
 - Files with converted formats are saved to the same directory as the original.
 - Do not select external media like floppy disk to save data.
 - Do not save data in a root directory.
 - Make sure there is enough memory before saving data.
 - It may take time to abort the Convert settings.
-

File format of converted data

For details on the file format of converted data, please see Section 6.15, "File Formats."

10.5 Restructuring Measurement Data Files

The “Restruct” function enables you to restructure data files by both Merging and Dividing them simultaneously. Files can be merged into a new file and divided into multiple files with new conditions.

Only files with a daq extension can be restructured.

For the output file name the extension will automatically be set to “daq.” A follow-up number will be added behind the original file name for distinction.

For example: file name_0000.daq (0000 being the follow-up number).

- 1 Click the Restruct tab to display the setting window for file restructuring.

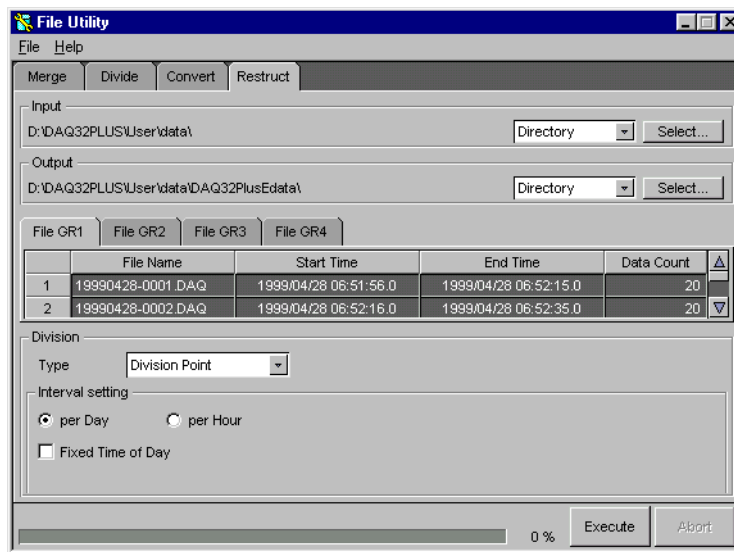

Selecting files to merge

- 2 To specify the original files you want to merge, first click the Select... button in the Input frame. In the dialog box that opens select the directory with the files you want to merge.
- 3 If there are different measurement data groups in the directory Group tabs will be displayed. Files within the same group can be merged. Click the Desired Group tab.
- 4 Select the files to be merged by dragging the numbers' column on the left side of the file list.

Note

- If you don't select any specific files, all the files within the group will be merged.
- To undo a selection, drag again.

Selecting the directory to save files to

- 5 In the Output frame select the directory to save the divided files to. Click the Select button and choose a directory in the dialog box.

Note

- Do not select external media like floppy disk to save data.
- Do not save data in a root directory.
- Make sure there is enough memory before saving data.

Division Settings

Please refer to Section 10.3, “Dividing Measurement Data Files for details of the settings.”

Note

Single Fixed cannot be selected for Restructuring.

- 6 Click Execute to reconstruct and Abort to cancel.

Output file names

The extension for output files will automatically be set to “daq.”

A follow-up number will be added behind the file name of the first file among original files for distinction.

For example

file name of the first original file_0000.daq

(0000 being the follow-up number)

11.1 Troubleshooting

If a message appears on the screen, refer to paragraph 11.2 on page 11-2.

Problem	Probable Cause/Corrective Action
The DA100/DC100/DR//DS does not turn ON. The DA100's status lamp does not turn ON.	The power supply is out of the ratings. Use an appropriate power supply.
The DA100's status lamp is blinking at one-second intervals.	The communication module is not installed properly. Install the communication module properly.
The DA100's status lamp is blinking at an interval other than one-second interval.	Internal error has occurred. Restart the DA100.
A connected subunit is not recognized.	The subunit is turned OFF. Turn the subunit ON. The extension cable is not connected properly to the subunit. Connect the extension cable properly.
A connected module is not recognized.	The module is not connected properly. Connect the module properly.
The measured value is not correct.	The input signal does not satisfy the specifications. Check the input specifications. The measurement mode is not correct. Change to an appropriate measurement mode. The measurement range, span, and scale settings are not correct. Change the settings to the correct values. Noise is affecting the measurement. Take measures to cut the noise. The reference junction compensation is not correct. Set the reference junction compensation correctly. The ambient temperature is outside the allowed range. Set the ambient temperature within the allowed range.
Cannot communicate properly.	The PC is in the power-saving or standby mode. Do not use the power-saving or standby mode. Using a screen saver. Do not use a screen saver. Communication settings are not correct. Check the switch settings on the communication module and check using the Software Configurator.
Communication is established, but fails to operate.	The DA100, DC100, or DR was turned OFF or the cable was disconnected while the communication was in progress. If the DA100, DC100, or DR is turned OFF or the network is disconnected while transferring setup data over the Ethernet, the timeout takes approximately three minutes. If the DA100, DC100, or DR is turned OFF or the network is disconnected while receiving data with the logger software, the timeout can take several hours.

11.2 Error Messages and Corrective Actions

Displayed when incorrect settings have been entered or when the instrument is malfunctioning. If the same problem still occurs after the proper corrective action has been taken, diagnose the problem using the diagnosis software.

Warning Messages

No.	Message/Description
W1102	Converted data file will be overwritten. OK?
W3304	Start Initializing?
W3305	Start Reconstructing?
W3315	Stop Calibration?
W3316	Send Calibration Values?
W3317	60 mV, 200 mV have not been calibrated. Do you want to continue?
W3318	Store Calibration Values?
W3319	Abort Calibration?
W3320	Initial Balance Failed. Retry?
W3332	Close network?
W3333	Set the network address?
W3451	Delete the current Project?
W3671	Please change connected hardware to SET mode.
W3672	Hardware model doesn't match software setting. Continue sending?
W3673	Style numbers don't match. Continue sending?
W3674	Hardware and Software configurations don't match. Continue sending data?
W3675	Hardware and Software options don't match. Continue sending?
W3676	Some data couldn't be read.
W3677	Some existing data were changed.
W3678	This is a reference channel. Channels referring to this channel will be changed too!
W3679	Settings of other power module channels will be changed too!
W3680	Some channels out of the copy range will be changed too!
W3681	Some channels can't be copied.
W3682	Writing operation was changed.
W3683	Following the change of temperature unit, SET (Regular) settings have been initialized.
W3684	The digital print settings of some measurement and Math channels have been changed.
W3685	The relay settings of some measurement and math channels were set OFF.
W3686	Some Event/Action settings have been changed.

Error Messages <Common>

No.	Message/Corrective action
E0001	Insufficient Memory. Exit other programs and restart, or reboot the OS and restart the program.
E0002	Insufficient Memory. Please close at once. Exit other programs and restart, or reboot the OS and restart the program.
E0003	Can't open shared memory. Exit other programs and restart, or reboot the OS and restart the program.
E0004	Incorrect License number. Reinstall with correct License number.
E0101	Please use DAQ32 launcher to open. Please use DAQ32 Plus launcher to open. Run the program from the launcher.
E0201	Can't open. No YOKOGAWA binary file. Cannot handle this file.
E0202	Can't open. No DARWIN binary file. Cannot handle this file.
E0203	No data available. Cannot handle this file.
E0211	Can't write to file. Check the directory's free space. Check that other programs are not using the file.

No.	Message/Corrective action
E0212	Can't read file. Check the existence of the file. Check that the file system is operating properly.
E0213	Can't open file. Check the existence of the file. Check that the file system is operating properly.
E0214	Insufficient disk capacity. Free disk space.
E0215	No such file. Check the existence of the file.
E0216	Illegal file name. Use a different file name.
E0401	Communication error. The Logger Software cannot communicate while the setup software is communicating. Check that the DARWIN is turned ON, the communication module is being recognized by the DARWIN (DR/DC), and the cable is connected properly. In addition, check the following items according to the communication methods. For GP-IB communication: Is the address correct? Is the driver is properly installed? Is the GPIB card manufactured by NI? For Ethernet communication: Is the address correct? Is the TCP/IP protocol installed in Windows? For RS-232-C, RS-422-A, and RS-485 Is the baud rate correct? Is the port (COM1 to COM4) correct? Is the address correct (RS422)? Is the PC's serial port functioning? Is the correct type of cable being used?
E0404	Can't load DLL of GPIB. Correctly install the GPIB driver.

Error Messages <Launcher>

No.	Message/Corrective action
E3401	Incorrect Password. Enter the correct password.
E3402	Passwords may not be blank. Enter the password.
E3403	Project names may not be blank Enter the project name.

Error Messages <Logger>

No.	Message/Corrective action
E3001	Incorrect File type or Version! The program will use default settings because the previous settings (such as display settings) could not be loaded.

11.2 Error Messages and Corrective Actions

Error Messages <Software Configuration>

No.	Message/Corrective action
E3301	Failed to scan. Check that the DARWIN is turned ON, the communication module is being recognized by the DARWIN (DR/DC), and the cable is connected properly. In addition, check the following items according to the communication methods. For GPIB communication: Is the address correct? Is the driver is properly installed? Is the GPIB card manufactured by NI? For Ether communication: Is the address correct? Is the TCP/IP protocol installed in Windows? Is the Ether card properly installed? For RS-232-C, RS-422-A, and RS-485 Is the baud rate correct? Is the port (COM1 to COM4) correct? Is the address correct (RS422)? Is the PC's serial port functioning? Is the correct type of cable being used?
E3302	Failed to reconstruct. See the corrective actions for E3301.
E3303	Failed to initialize. See the corrective actions for E3301.
E3306	Fail to make directory. Check the directory path and name.
E3312	Select all ranges that has invalid values. Even though there is a range with an invalid calibration value, that range is not selected. Select the range with the invalid calibration value and calibrate it.
E3313	Failed to calibrate. Check that the module is connected properly. Check the wiring, rated input, and etc.
E3314	For xxx is invalid. Enter the correct value.
E3331	There is no module. Or there are many modules. Several modules exist when setting up the network. Specify only one module.
E3337	The address is invalid. Properly set the combination of the IP address, subnet mask, and default gateway.
E3338	Can not set the network address. An error occurred while setting the address.
E3339	Modules not found. Set the module's dipswitch and turn DARWIN ON. Check that the cables are connected properly.

Error Messages <Historical Viewer>

No.	Message/Corrective action
E3101	No data. Valid data do not exist.
E3102	No channels. Valid channel does not exist.

Error Messages <DARWIN Hardware Configuration>

No.	Message/Corrective action
E3631	Communication not possible during logging. Terminate Logger's communication before executing.
E3632	Communication not possible while monitoring data. Terminate Logger's communication before executing.
E3633	Connected to unknown model. Modify the system or change the settings.
E3636	Failed to send command. Some items could not be set. Check the setup data.
E3637	Can't reconstruct. Displayed when the DR stand-alone model is connected.
E3638	Initial balancing failed. Check the input, initialize, and perform initial balancing again. If it fails again, servicing is needed.
E3639	Incorrect file name! Check the file name and extension.
E3640	File operation failed. Check the free space on the PC's hard drive. Check that the hard disk is operating properly.
E3641	These data were generated by another model. Select a different file.
E3643	Failed to load data. Some data initialized. Check the setup data.
E3644	Invalid channels are included in the copy source. Check the copy source and copy destination settings.
E3645	Please enter an equation. Enter an equation.
E3646	Unknown symbol is entered. Please change equation. Check the setup data.
E3647	Invalid channel number is entered. Please change equation. Check the channel number.
E3648	Incorrect use of parenthesis. Please change equation. Check the setup data.
E3649	Grammatical error. Please change equation. Check the setup data.
E3650	Character string is incorrect. Check the setup data.
E3651	Invalid channel number. Change the channel number.
E3652	For input range, please keep CH numbers: Left < Right. Check the setup data.
E3653	Channel number is already being used! Check the setup data.

Messages

No.	Message/Corrective action
M3404	Invalid Project name. Please enter a new name.
M3405	This Project name is already being used. Please enter a new Project name.
M3406	There must be at least one unlocked Project.
M3407	Can't contain any of the following characters / : , ; * ? " < >
M3031	Do you want to stop recording ?
M3032	Please stop Measuring before you exit.
M3033	You must Unlock and enter a Password to Exit.
M3231	Send Tags?
M3232	Send Tag IDs?
M3601	Start Receiving?
M3602	Start Sending?
M3603	Reconstruct?
M3604	File is already open. Reopen will cause your changes to be discarded. Do you want to reopen?
M3605	All settings will be initialized!
M3606	SET (Regular) settings will be initialized!
M3607	Add Unit?
M3608	Delete Unit?

Index

A

A/D	
converter integration time.....	4-41
A/D integral time.....	1-11
AC.....	4-8
Alarm	
Acknowledgement.....	5-15
display.....	5-10
displaying info.....	6-16
interval.....	4-43
monitor display.....	5-15
noise.....	5-10
output relay hold/non-hold.....	1-15
settings.....	4-11, 5-15
time before file end.....	4-53
type.....	4-11
value.....	4-12
alarm hysteresis.....	1-13
alarm output relay AND/OR.....	1-14
alarm output relay de-energize.....	1-14
alarm output relay energize.....	1-14
alarm setting.....	1-12
ASCII-converted file.....	6-23
ASCII data files.....	5-4
Auto Processor.....	5-24
auto zone.....	6-9

B

boundary value.....	4-16
burn-out.....	4-45

C

calibration	
auto.....	8-2
displaying screen.....	8-1
manual.....	8-4
channel	
display indication.....	4-55
number display.....	4-51
number print pitch.....	4-52
selecting display.....	6-17
chart speed.....	4-52
chart speed 1.....	4-36
chart speed 2.....	4-36
Client Package.....	i
Client Package software.....	1-5
clip limiter.....	6-8, 6-9
closing software.....	1-6
color display.....	5-9
columns.....	4-52
communication	
interface.....	3-6
communication settings.....	3-4
computation	
equation.....	4-24
computation (uniquely for DA100 with /M1 option).....	1-17
computing types.....	1-22
configuration	
logging.....	5-2
module.....	4-57
system.....	4-56

confirming ROM version.....	3-9
connection conditions.....	9-4
constants.....	4-27
converted file formats.....	6-23
converting data formats.....	6-21
copy-lock	
password.....	4-54
to floppy disk.....	4-54
copying	
channel settings.....	4-25, 5-6
settings.....	6-7
corrective actions.....	11-2
cursor measurement.....	5-16, 6-11, 6-14

D

D2 option.....	4-49
DA100 functions.....	1-8
DAQ 32 Plus.....	1-5
version information.....	2-5
DAQ 32 Plus Client Package.....	1-5
DARWIN Hardware Configurator.....	4-1
DC voltage.....	1-8
DC voltage input (VOLT).....	1-9
DDE server.....	5-23
Default Gateway.....	3-2
DELTA.....	4-7
DELTA (difference between channels).....	1-8
DI.....	1-10, 4-8
DI (voltage level: LEVL; contact:CONT).....	1-8
digital	
printout ON/OFF.....	4-15
printout setting.....	4-17
value display.....	5-10
display	
indication.....	4-55
update interval.....	4-55
dot-printing.....	4-51

E

edge action.....	4-29
edit zone.....	5-12, 6-8
Equations.....	1-20
equations.....	4-23
error messages.....	11-2
Ethernet communication.....	3-1
event/action.....	1-16, 4-28
Excel-converted file.....	6-23

F

faulty data.....	1-24
file	
deleting oldest.....	4-53
deletion when copying.....	4-53
overwriting, same name.....	4-53
file formats.....	6-24
File Utility software.....	1-3
filter.....	4-14, 4-41
full zone.....	5-13, 6-8

Index

G

general display settings.....	6-5
GP-IB communication.....	3-1
grid, adjusting.....	5-14
group	
display.....	5-10
group name.....	5-5, 6-5
group settings.....	5-5

H

Hardware Configurator	
display settings.....	4-61
header.....	4-36
Historical Viewer	
introduction.....	6-1
starting.....	6-1
hysteresis.....	4-43

I

initializing settings.....	4-58
Input	
types.....	1-8
input	
type for linear scaling.....	4-8
input filter.....	1-12
input range.....	4-5, 4-6
internal switches.....	4-13, 4-44
interpolation.....	4-15, 4-16
IP address.....	3-2

K

keylock	
setting.....	4-55

L

labeling, tag/channel.....	5-14
Launcher Software	
introduction.....	2-1
Launcher software.....	1-1
level action.....	4-29
limiter.....	5-14
linear scaling.....	4-5
linking	
other monitors.....	5-14
list format.....	4-36
List printout.....	4-15
list printout.....	4-17
loading	
setting conditions.....	4-3
loading files.....	5-19
Logger software	
operating.....	5-1
starting.....	5-1
Logging configuration.....	5-2, 5-17
logging mode.....	4-35
logging status check.....	5-22
Lotus-converted file.....	6-23

M

mA.....	4-8
mA (DC current, mA input module).....	1-8
mA input (mA).....	1-10
manual printout.....	4-15, 4-17
match times.....	4-29

math

actions.....	5-20
channel.....	4-23
math for PULSE input module.....	1-19
measurement period.....	1-11
memory settings.....	4-53
meter display.....	5-9
module	
adding/removing.....	4-57
Module configuration.....	4-57
monitor display.....	5-12
changing.....	5-12
stopping/pausing.....	5-11
monitoring interval.....	5-2
monitors.....	5-8, 5-9, 5-10
Monitor Server.....	5-26
moving average.....	1-12, 4-14
multi-axis zone.....	5-13

N

network settings.....	3-2
notepad copying.....	6-15

O

opening files.....	6-3
opening software.....	1-6
operators.....	1-20
output formats.....	1-21
overwrite function.....	4-4

P

partial expanded recording.....	4-17
partially expanded recording.....	4-16
PC environment.....	1-4
power failures during reporting.....	1-24
power module.....	4-10
power monitor.....	4-8
power monitor (AC).....	1-10
pretrigger.....	4-40
printing	
settings.....	4-62, 6-30
settings (DR only).....	4-35
vertical.....	4-52
waveforms.....	5-22
print settings.....	6-30
project	
changing/deleting.....	2-3
function.....	2-1
protection.....	2-4
saving, new.....	2-2
settings.....	2-2
switching.....	2-4
protection settings.....	2-1
PULSE.....	4-8
pulse input (PULSE).....	1-10

R

reconstruction.....	3-6
recording	
colors (DR only).....	4-45
format (DR only).....	4-51
interval.....	5-2
Interval, digital print/logging mode.....	4-52
modes.....	4-35
start/end.....	5-2
starting/stopping.....	5-17
zones.....	4-15

reference junction compensation..... 4-45
 reflash alarm..... 1-15
 reflashing alarm..... 4-44
 relay (de-)energizing..... 4-44
 relay AND/OR..... 4-44
 relays..... 4-13
 Remote Monitor software..... 1-3
 remote RJC(RRJC)..... 1-11
 Report
 time..... 1-22
 report
 auto-printing..... 5-24
 automatic conversion..... 5-24
 data conversion..... 6-32
 displaying..... 6-32
 printing..... 6-32
 settings..... 4-46
 report channels..... 1-22
 resistance temperature detector (RTD)..... 1-10
 RRJC..... 4-7
 RS-232-C..... 3-4
 RS-232-C/RS-422-A/RS-485 communication..... 3-1
 RS-422-A/RS-485..... 3-4
 RTD..... 4-8
 RTD (resistance temperature detector)..... 1-8

S

saving
 channel settings..... 5-3
 files..... 5-19
 selecting directory..... 3-5
 settings..... 4-60
 scale
 check mark printing..... 4-52
 printout..... 4-15
 scale/span (SCALE)..... 1-9
 scale conversion..... 1-9
 scale printout..... 4-17
 scan interval..... 4-41
 SCSI ID Number..... 4-49
 sending settings..... 4-59
 setting screen..... 4-1
 setting the measurement range..... 1-9
 Setting up
 DAQ32 Plus..... 1-5
 DAQ 32 Plus Client Package..... 1-5
 slide zone..... 5-12, 5-13, 6-8
 Software Configurator
 introduction..... 3-1
 starting..... 3-1
 software license..... ii
 some report math functions (optional)..... 1-21
 span..... 4-5, 4-10
 setting..... 4-7
 standard toolbar..... 4-61
 statistical calculations..... 6-14
 status bar..... 4-61
 strain..... 4-7, 4-8
 strain input (STRAIN)..... 1-10
 subnet mask..... 3-2
 subunit
 adding/removing..... 4-57
 Summer/Winter time setting..... 4-33
 System configuration..... 4-2, 4-56
 system initialization..... 3-8
 System reconstruction..... 3-6
 system scan..... 3-7

T

Tag
 copying..... 7-3
 display..... 4-51
 display indication..... 4-55
 editor..... 7-1
 pasting..... 7-3
 print characters..... 4-51
 receiving data..... 7-2
 saving to tag file..... 7-4
 selecting display..... 6-17
 setting..... 4-19, 7-3
 sorting..... 7-3
 writing data to DC100/DR..... 7-4
 Tag ID..... 4-61
 copying..... 7-3
 pasting..... 7-3
 selecting display..... 6-17
 setting..... 7-3
 sorting..... 7-3
 TC..... 4-8
 temperature unit..... 4-49
 thermocouple (TC)..... 1-8, 1-9
 time axis
 changing..... 5-12
 scale for TLOG SUM..... 4-48
 setting..... 6-10
 zooming..... 5-12
 timers..... 4-33
 title..... 4-36
 title printing pitch..... 4-52
 TLOG.PSUM..... 4-49
 toolbar..... 4-61
 trend mode..... 4-35
 trend recording..... 4-15, 4-17
 trigger marks..... 6-18
 trip points..... 5-6, 6-6
 troubleshooting..... 11-1

U

user defined marks..... 6-18, 6-19
 user zone..... 5-13, 6-8

V

Viewer software..... 6-2
 VOLT..... 4-8

W

warning messages..... 11-2
 waveform display zone..... 5-12, 6-8
 wiring..... 4-6
 writing data length..... 4-40

Y

Y-axis..... 5-14

Z

zone
 setting..... 6-8
 types..... 5-12
 zones..... 4-15